

## REQUEST FOR PROPOSALS

### Sleighville Project Tahoe National Forest, California

**Background and Statement of Work:** The National Forest Foundation (NFF) and the USDA Forest Service (Forest Service) are working together to protect and restore the Tahoe National Forest through targeted efforts in the NFF's Tahoe Headwaters Treasured Landscape site. The NFF and the Yuba River Ranger District (YRRD) of the Tahoe National Forest are collaborating on the 3,543 acre Sleighville Project. The Sleighville Project is a fuel reduction and commercial thinning project designed to reduce wildfire risk by thinning over-stocked forests around the rural communities along the North Yuba River corridor, improve forest health and resilience, and generate enhanced stream flow.

The Sleighville Project has been divided into four phases, based on location and treatment method, Phase I – Tractor Based Units, Phase II – Tractor Based Units, Phase III – Cable Based Units, and Phase IV – Helicopter Units. Item 6, reconstruction of all roads in the Sleighville Roads Package, is being advertised as a stand-alone item. **Bidders may bid on one or multiple phases and must bid on all items within the phase they are bidding.** The awarded Contractor(s) for each phase will be selected based on the evaluation factors and guidelines listed in Part III of this Request for Proposals. Bidders may be awarded one or multiple phases as determined by strategic benefit to the NFF and the total scores for each phase.

#### Phase I

The awarded Contractor will complete 1,291 acres of thinning and removal of merchantable conifers with tractor based operations in accordance with relevant specifications identified in Appendix F, including up to 16.6 miles of road maintenance. Additional service work will include fuels reduction on up to 1,291 acres within the Phase I commercial thinning units, and wood product processing and transportation in accordance with specifications identified in Appendix E. Securing county road encroachment permits for maintenance, hauling, or other operations within Phase I of the Sleighville Project is the responsibility of the awarded Contractor.

#### Phase II

The awarded Contractor will complete 970 acres of thinning and removal of merchantable conifers with tractor based operations in accordance with relevant specifications identified in Appendix F, including up to 18 miles of road maintenance. Additional service work will include fuels reduction on up to 680 acres within the Phase II commercial thinning units, and wood product processing and transportation in accordance with specifications identified in Appendix E. Securing county road encroachment permits for maintenance, hauling, or other operations within Phase II of the Sleighville Project is the responsibility of the awarded Contractor.

#### Phase III

The awarded Contractor will complete 1,110 acres of thinning and removal of merchantable

conifers with aerial based operations on slopes greater than 40% in accordance with relevant specifications identified in Appendix E and Appendix F, including up to 20.3 miles of road maintenance. The logging plan for these units was designed for cable yarding systems, however, Bidders may propose to use cable yarding, tethered equipment, skyline yarding systems, or helicopter operations if this is their preferred approach. One tractor based unit (4 acres) is included in Phase III due to the proximity to surrounding aerial based units. Additional service work will include fuels reduction on up to 88 acres within the Phase III commercial thinning units, and wood product processing and transportation in accordance with specifications identified in Appendix E. Securing county road encroachment permits for maintenance, hauling, or other operations within Phase III of the Sleighville Project is the responsibility of the awarded Contractor.

#### **Phase IV**

The awarded Contractor will complete 172 acres of thinning and removal of merchantable conifers by helicopter operations in accordance with relevant specifications identified in Appendix F. Additional service work will include wood product processing and transportation in accordance with specifications identified in Appendix E. Securing county road encroachment permits for maintenance, hauling, or other operations within Phase IV of the Sleighville Project is the responsibility of the awarded Contractor.

#### **Sleighville Roads Package**

The awarded Contractor will complete 20.8 miles of road reconstruction in accordance with the specifications included in the Sleighville Roads Package. This item is a public works project, and is governed by the prevailing wage requirements of The Miller Act. All road reconstruction must be completed and approved by July 31, 2025.

#### **Information Requested**

If interested in submitting a bid for this project, please provide a proposal for the applicable phase(s) in which you are bidding by providing:

- technical approach and production capacity
- experience in similar projects
- cost
- availability for this project

Specific requirements are detailed below.

## **I. PROJECT OVERVIEW AND REQUIREMENTS**

#### **General Specifications**

- (a) Description of Work – This Request for Proposals is for conifer removal operations and additional project related service work. The specific work activities are identified in the Schedule of Items tables in Appendix E. Additional information, requirements, and specifications for each item are provided in the attached appendices. Please see Appendix F for specific operating considerations within each conifer removal unit.

This project uses advanced technologies, which will be provided to the awarded bidder

for treatment and accomplishment tracking. All provided equipment will be returned to EarthForce Technologies at project completion. Utilizing advanced technologies as identified in Appendix I will be a mandatory component of the forthcoming contract.

### Phase I

1. Commercial thinning removal of conifers from 10 inches to 29.9 inches in diameter at breast height (dbh) on up to 1,291 acres in accordance with Appendix F and protection measures in Appendix E. Includes 16.6 miles of road maintenance. Securing county road encroachment permits is the responsibility of the awarded bidder.
  - a. Tractor units (up to 1,291 acres). Ground-based equipment will be used to meet treatment specifications in Appendix E and Appendix F.
2. Small tree thinning of conifers and brush 3 – 9.9 inches dbh and surface fuels on up to 1,291 acres in accordance with specifications in Appendix E.
  - a. Machine cut and remove to landing (1,291 acres).
3. Wood product processing and transportation of up to 119,711 GT of saw timber, non-saw timber, and biomass in accordance with Appendix E.
  - a. Saw timber processing and transportation of up to 81,357 GT.
  - b. Non-saw timber processing and transportation of up to 9,454 GT.
  - c. Biomass processing and transportation of up to 28,900 GT.
4. Temporary road construction – 2.9 miles
5. Water draft site development and/or water purchasing. Water draft sites as shown in Appendix C may need to be developed for use on all road work in accordance with specifications in Appendix E. Alternatively, water may be purchased to complete road maintenance and road reconstruction specifications.

### Phase II

1. Commercial thinning removal of conifers from 10 inches to 29.9 inches in diameter at breast height (dbh) on up to 970 acres in accordance with Appendix F and protection measures in Appendix E. Includes 18 miles of road maintenance. Securing County Road encroachment permits is the responsibility of the awarded bidder.
  - a. Tractor units, up to 970 acres. Ground-based equipment will be used to meet treatment specifications in Appendix E and Appendix F.
2. Small tree thinning of conifers and brush 3 – 9.9 inches dbh and surface fuels on up to 680 acres in accordance with specifications in Appendix E.
  - a. Machine cut and remove to landing (680 acres).
3. Wood product processing and transportation of up to 95,272 GT of saw timber, non-saw timber, and biomass in accordance with Appendix E.
  - a. Saw timber processing and transportation of up to 70,636 GT.
  - b. Non-saw timber processing and transportation of up to 7,986 GT.
  - c. Biomass processing and transportation of up to 16,650 GT.
4. Temporary road construction – 2.7 miles
5. Water draft site development and/or water purchasing. Water draft sites as shown in Appendix C may need to be developed for use on all road work in

accordance with specifications in Appendix E. Alternatively, water may be purchased to complete road maintenance and road reconstruction specifications.

### Phase III

1. Commercial thinning removal of conifers from 10 inches to 29.9 inches in diameter at breast height (dbh) on up to 1,110 acres in accordance with Appendix F and protection measures in Appendix E. Includes 20.3 miles of road maintenance. Securing county road encroachment permits is the responsibility of the awarded bidder.
  - a. Cable units, up to 1,106 acres. Cable, or other aerial, based equipment will be used to meet treatment specifications in Appendix E and Appendix F.
  - b. Tractor units, up to 4 acres. Ground based equipment will be used to meet treatment specifications in Appendix E and Appendix F.
2. Small tree thinning of conifers and brush 3 - 9.9 inches dbh and surface fuels on up to 88 acres in accordance with specifications in Appendix E.
  - a. Machine cut and remove to landing (4 acres).
  - b. Hand cut/hand pile (84 acres).
3. Wood product processing and transportation of up to 75,531 GT of saw timber, non-saw timber, and biomass in accordance with Appendix E.
  - a. Saw timber processing and transportation of up to 68,524 GT.
  - b. Non-saw timber processing and transportation of up to 7,008 GT.
  - c. Biomass processing and transportation of up to 25,000 GT.
4. Temporary road construction - 1.2 miles
5. Water draft site development and/or water purchasing. Water draft sites as shown in Appendix C may need to be developed for use on all road work in accordance with specifications in Appendix E. Alternatively, water may be purchased to complete road maintenance and road reconstruction specifications.

### Phase IV

1. Commercial thinning removal of conifers from 10 inches to 29.9 inches in diameter at breast height (dbh) on up to 172 acres in accordance with Appendix F and protection measures in Appendix E.
  - a. Helicopter units, up to 172 acres. Helicopter equipment will be used to meet treatment specifications in Appendix E and Appendix F.
2. Wood product processing and transportation of up to 11,563 GT of saw timber and non-saw timber with Appendix E.
  - a. Saw timber processing and transportation of up to 10,508 GT.
  - b. Non-saw timber processing and transportation of up to 1,055 GT.

### Sleighville Road Reconstruction Package

Road reconstruction of up to 20.8 miles of road in accordance with the Sleighville Road Package. Securing county road encroachment permits for reconstruction is the responsibility of the awarded bidder. All road reconstruction must be completed and approved by July 31, 2025.

Permits: The awarded Contractor will be responsible for obtaining any necessary permits for access, hauling and other operation across county owned roadways. Encroachment permits will be needed. Bidders or awarded Contractor(s) should reach out to Bryan Davey (530-289-3201 or publicworks@sierracounty.ca.gov) with any questions.

The full Scope of Work can be found in Appendix E – Schedule of Items and Specifications. Bidders shall identify what they can supply in terms of materials, labor, equipment, supplies, supervision, quality control, and incidentals required to complete the work described. Bidders shall ensure that proposals allow for the performance of all work in a safe and conscientious manner.

- (b) Project Location – The Sleighville Project is in the Yuba River Ranger District of the Tahoe National Forest in Sierra County. The project area extends east from the community of Camptonville up FS RD 293 and continues north towards Goodyears Bar. Appendix C includes a map of the project displaying the entire project area within which treatments may occur. The project area lies within the Yuba River Ranger District of the Tahoe National Forest T19N, R08E, Sections 24, 25 T19N, R09E, 13, 14, 15, 17, 19, 20, 21, 22, 23, 24, 27, 28, 29, 30, 21, 32; T19N, R10E Sections 11 and 18.
- (c) Work Schedule – Work for Phase I will commence as early as March of 2025 and run year-round (weather permitting) until December 31, 2029. Work for Phase II, III, and IV may commence as recommended by the awarded Contractor(s) and will run year-round (weather permitting) until December 31, 2029. Anticipate delays each summer and fall for Project Activity Level (PAL) days where limited work is allowed due to fire restrictions. The PAL system may be replaced by the Industrial Fire Precaution Activity Level (IFPAL) system upon authorization from the Forest Service. Non-operational days due to PAL or IFPAL restrictions will not be compensated. Bidders should plan accordingly when submitting proposals. Snow cover and wet ground may prevent mechanical work during periods in the winter months (November – May). Operations shall follow the criteria outlined in the Outside Normal Operating Season Standards (ONOSS) document to determine if conditions are favorable for activities and to determine as to when conditions warrant suspension of operations. Operation units may fall inside of California Spotted Owl (CSO) and Northern Goshawk (NOGO) Protected Activity Centers, and Limited Operational Periods overlap into project area. Restrictions on mechanical activities could occur from February 15th to September 15th. All work must be completed by December 31, 2029. The NFF and awarded Contractor(s) will negotiate a schedule of operations upon award, with mandatory benchmarks to meet NFF’s desired goals for project progress. Examples of mandatory benchmarks may include, but are not limited to:

End Year	Phase I	Phase II	Phase III	Phase IV	Road Package
2025	Initiated, 300 acres complete	Initiated, 100 acres complete	Initiated		All road reconstruction complete
2026	600 acres complete	600 acres complete	300 acres complete		
2027	200 acres complete	200 acres complete	300 acres complete	Initiated	

2028	Phase I complete	Phase II complete	300 acres complete	Phase IV complete	
2029			200 acres complete, Phase III complete		

NOTE: Mandatory benchmarks are subject to adjustment by NFF based on purchase orders and agreements that NFF secures for each subsequent year.

**Other Project Requirements and Specifications**

(a) Utilities – In many locations there will be no or limited sanitation, water, electrical or housing services available. The awarded Contractor shall make its own arrangements for temporary facilities if needed.

(b) Specifications – Project work shall be accomplished in accordance with the following:

- APPENDIX A – Federal Flow Down Provisions
- APPENDIX B – Omitted
- APPENDIX C – Sale Area Map
- APPENDIX D - Omitted
- APPENDIX E – Schedule of Items and Specifications (Service Work)
- APPENDIX F – Timber Removal Specifications
- APPENDIX G – Guidelines for Operations
- APPENDIX H – Fire Plan
- APPENDIX I – Advanced Technologies Requirement
- APPENDIX J.1 - Road Maintenance Package
- APPENDIX J.2 - Road Reconstruction Package
- Sleightville cruise data and unit boundary shapefiles

Use this link to download the above listed documents: <https://nff.files.com/f/97fb181d6b16acfe>

**Insurance Requirements**

Upon selection of the winning bid, the awarded Contractor(s) agrees that it has and shall maintain the following insurance coverage indicated below. The effective date of all coverage shall precede the start of any work.

- a. State minimum workers’ compensation insurance coverage for its employees, if any.
- b. Broad form general liability, property damage, and automotive liability insurance in the minimum amount of \$1,000,000 for bodily injury, death, or damage to property of any person and \$2,000,000 for bodily injury, death, or damage to property of more than one person. The awarded Contractor shall name NFF an Additional Named Insured and provide NFF with a certificate of insurance evidencing such coverages, prior to the initiation of the Scope of Services.
- c. If the Scope of Services includes professional services as identified herein, the

awarded Contractor shall also provide professional errors and omissions liability insurance. Professional services for purposes of this section include, but are not limited to performing architecture, engineering, landscape architecture, land surveying or planning, preparation and signing or stamping of drawings, maps, surveys or construction specifications, or design and development of computer software, programs or websites by the awarded Contractor or by subcontractors on behalf of the awarded Contractor, for which professional liability insurance would typically be required. The minimum coverage limits required are \$1,000,000 for each claim and \$1,000,000 annual aggregate.

### **Prohibited Telecommunications Services and Equipment**

If required, the awarded Contractor(s) is responsible for compliance with the prohibition on certain telecommunications and video surveillance services or equipment identified in 2 CFR 200.216.

### **Payment/Performance Security**

Awarded Contractor(s) shall post cash, a letter of credit, bond, or other financial security that is easily convertible into cash in a form acceptable to the NFF, in its sole determination, to assure completion of the work required under any subsequent agreement and payment of all amounts lawfully due to all persons supplying or furnishing to the awarded Contractor or the awarded Contractor's subcontractors with labor, laborers, materials, rental machinery, tools or equipment used or to perform the work. The awarded Contractor may incorporate required associated costs into mobilization costs or other approved expenses.

- a. Work that is classified as construction in accordance with the Miller Act or Little Miller Act or if required per conditions of the funding source, payment and performance bonding will be required in the full amount of any Agreement. For the purposes of this Request for Proposal, construction is defined as "any contract greater than \$100,000 for the construction, alteration, or repair of any public building or public work where the federal government is the owner", or
- b. If the awarded Contractor is not self-performing at least 85% of the total contract value or if the cost of materials is in excess of the larger of \$100,000 or 50% of the contract total, payment and performance bonding will be required in the full amount of the agreement, or
- c. If the value of the agreement is in excess of \$250,000, the awarded Contractor will be required to post financial security in a form acceptable to the NFF in the amount of 5% of the total agreement value up to \$250,000 in total financial security.

### **Federal Exclusion Verification**

The awarded Contractor(s) will be required to affirm that neither it nor its principals are presently debarred, suspended, proposed for debarment, declared ineligible, or voluntarily excluded from participation in this transaction by any Federal department or agency.

### **Federal Flowdown Provisions**

Flowdown Requirements: Any Agreement associated with this RFP may be subject to flowdown requirements under associated federal or state funding agreements, which are included and

made part of by this reference.

## II. REQUIRED COMPONENTS

### Technical Proposal

Please provide a detailed technical approach to the work. The Technical approach should include the following items, if applicable:

- I. Timeline/schedule of operations – detailed timetable for project operations, including proposed start date, completion date, and how key milestones will be met. Timeline can be represented as a Gantt Chart, narrative or other format that accurately depicts operational schedule.
- II. Harvesting plan - detailed description of proposed harvesting plan, including harvesting methods, equipment to be used, and any innovative approaches to minimize environmental impact and increase production.
- III. Environmental considerations - outline approach to environmental protection and mitigation measures, such as erosion control, protection of sensitive habitats/resources, and adherence to applicable regulations like the Endangered Species Act.
- IV. Road maintenance – Information on the maintenance of access roads necessary for timber and biomass extraction. This should cover road design for temporary roads, maintenance schedules, erosion control measures, and necessary permits.
- V. Commercial thinning - information on the true costs combined into commercial thinning line Item 1. This should include a narrative of the costs of reopening temporary roads, constructing and decommissioning of new temporary roads, and road maintenance.
- VI. Road reconstruction (if submitting a bid for Item 6) – Information on the reconstruction of access roads necessary for timber and biomass extraction. This should cover road design and schedule, erosion control measures, and necessary permits.

### Bidder Qualifications

- I. Past Experience – Please provide a brief explanation of previous work experience with land management agencies. Include any experience pertaining to federal timber sales and steep slope thinning operations.
- II. References – Please provide three professional references that can speak to past performance.

### Pricing Schedule

Bidders shall price work according to the schedules below. Please indicate which phase you are bidding on, and only submit pricing schedules for the applicable phase(s) in which you are bidding. Prevailing wages are required for a portion of the work per conditions of funding sources, as indicated below. **The awarded Contractor(s) is responsible for determining the**



**correct wage classifications and prevailing wage for each category.** For Item 3: Wood Product Processing and Transportation, please provide a bid to each of the receiving facilities listed in the table following the pricing schedules. Use the highest haul unit cost to calculate the extended cost for Items 3a, 3b, and 3c in the pricing schedules per phase.

For the Sleightville Project in the state of California, federal prevailing wages **ARE NOT** applicable to the following tasks:

<b>Phase I: Tractor Based Units</b>					
<b>Item #</b>	<b>Description</b>	<b>Unit of Measure</b>	<b>Quantity</b>	<b>Unit Cost (\$)</b>	<b>Extended Cost (\$)</b>
<b>01</b>	<b>Commercial Thinning (Includes up to 16.6 miles of road maintenance)</b>	<b>Acre</b>	<b>1,291.1</b>		
<b>02</b>	<b>Small Tree Thinning</b>	<b>Acre</b>	<b>1,291.1</b>		
a.	Machine Cut and Remove to Landing	Acre	1,291.1		
<b>03</b>	<b>Wood Product Processing and Transportation</b>	<b>GT</b>	<b>119,711</b>		
a.	Saw Timber*	GT	81,357		
b.	Non-saw Timber*	GT	9,454		
c.	Biomass (tops/limbs/slash/remove to landing)*	GT	28,900		
<b>04.</b>	<b>Temporary Road Construction</b>	<b>Mile</b>	<b>2.9</b>		
<b>05.</b>	<b>Water Draft Site Development AND/OR Water Purchasing</b>	<b>Draft Site</b>	<b>3</b>		
		<b>Lump Sum</b>	<b>1</b>		
<b>Phase I Total</b>					

\* Enter the highest unit cost per item from the Wood Processing Receiving Facilities table to calculate the extended cost for Items 3a, 3b, and 3c.

<b>Phase II: Tractor Based Units</b>					
<b>Item #</b>	<b>Description</b>	<b>Unit of Measure</b>	<b>Quantity</b>	<b>Unit Cost (\$)</b>	<b>Extended Cost (\$)</b>
<b>01</b>	<b>Commercial Thinning (Includes up to 18 miles of road maintenance)</b>	<b>Acre</b>	<b>969.4</b>		
<b>02</b>	<b>Small Tree Thinning</b>	<b>Acre</b>	<b>679.7</b>		
a.	Machine Cut and Remove to Landing	Acre	679.7		
<b>03</b>	<b>Wood Product Processing and Transportation</b>	<b>GT</b>	<b>95,272</b>		
a.	Saw Timber*	GT	70,636		
b.	Non-saw Timber*	GT	7,986		
c.	Biomass (tops/limbs/slash/remove to landing)*	GT	16,650		

<b>04.</b>	<b>Temporary Road Construction</b>	<b>Mile</b>	<b>2.7</b>		
<b>05.</b>	<b>Water Draft Site Development AND/OR</b>	<b>Draft Site</b>	<b>4</b>		
	<b>Water Purchasing</b>	<b>Lump Sum</b>	<b>1</b>		
<b>Phase II Total</b>					

\* Enter the highest unit cost per item from the Wood Processing Receiving Facilities table to calculate the extended cost for Items 3a, 3b, and 3c.

<b>Phase III: Cable Units</b>					
<b>Item #</b>	<b>Description</b>	<b>Unit of Measure</b>	<b>Quantity</b>	<b>Unit Cost (\$)</b>	<b>Extended Cost (\$)</b>
<b>01</b>	<b>Commercial Thinning (Includes up to 20.3 miles of road maintenance)</b>	<b>Acre</b>	<b>1,110.3</b>		
a.	Cable	Acre	1,106.3		
b.	Tractor	Acre	3.9		
<b>02</b>	<b>Small Tree Thinning</b>	<b>Acre</b>	<b>88.1</b>		
a.	Machine Cut and Remove to Landing	Acre	3.9		
b.	Hand Cut/Hand Pile	Acre	84.2		
<b>03</b>	<b>Wood Product Processing and Transportation</b>	<b>GT</b>	<b>100,532</b>		
a.	Saw Timber*	GT	68,524		
b.	Non-saw Timber*	GT	7,008		
c.	Biomass (tops/limbs/slash/remove to landing)*	GT	25,000		
<b>04.</b>	<b>Temporary Road Construction</b>	<b>Mile</b>	<b>1.2</b>		
<b>05.</b>	<b>Water Draft Site Development AND/OR</b>	<b>Draft Site</b>	<b>3</b>		
	<b>Water Purchasing</b>	<b>Lump Sum</b>	<b>1</b>		
<b>Phase III Total</b>					

\* Enter the highest unit cost per item from the Wood Processing Receiving Facilities table to calculate the extended cost for Items 3a, 3b, and 3c.

<b>Phase IV: Helicopter Units</b>					
<b>Item #</b>	<b>Description</b>	<b>Unit of Measure</b>	<b>Quantity</b>	<b>Unit Cost (\$)</b>	<b>Extended Cost (\$)</b>
<b>01</b>	<b>Commercial Thinning</b>	<b>Acre</b>	<b>171.8</b>		
<b>03</b>	<b>Wood Product Processing and Transportation</b>	<b>GT</b>	<b>11,563</b>		
a.	Saw Timber*	GT	10,508		
b.	Non-saw Timber*	GT	1,055		
<b>Phase IV Total</b>					

\* Enter the highest unit cost per item from the Wood Processing Receiving Facilities table to calculate the extended cost for Items 3a and 3b.

<b>Wood Product Receiving Facilities</b>					
<b>Item #</b>	<b>Description</b>	<b>Receiving Facility</b>	<b>Delivery Address</b>	<b>Unit of Measure</b>	<b>Unit Cost (\$)</b>
<b>03a.</b>	<b>Saw Timber</b>	SPI – Lincoln	1445 California 65, Lincoln, CA 95648	GT	
		SPI - Quincy	1538 Lee Road, Quincy, CA 5971	GT	
		SPI – Oroville	3025 South 5th Avenue, Oroville, CA, 95965	GT	
		Trinity River Lumber Co	Receiving yard: 3000 S 7th Ave. Oroville, Ca 95965	GT	
		Mendicino Forest Products LLC	Receiving yard: 4341 Chippewa Trail, Marysville, CA 95901	GT	
		Tahoe Forest Products	3736 Vista Grande Blvd, Carson City, NV 89705	GT	
		Camptonville Community Partnership	11639 Marysville Road, Dobbins, CA 95935	GT	
		Timber Products Company	130 North Phillipe Lane, Yreka, CA 96097	GT	
		Roseburg Forest Products	98 Mill Street, Weed, CA 96094	GT	
		Sierra Valley Enterprises LLC	100 Railroad Ave, Loyalton, CA 96118	GT	
		Alpenglow Timber	Klondike Flat Rd, Truckee, CA 96161	GT	
<b>03b.</b>	<b>Non-saw Timber</b>	Washoe Tribe Wood for Elders Gardnerville, NV	919 U.S. Hwy 395 N, Gardnerville, NV 89410	GT	
		Camptonville Community Partnership	11639 Marysville Road, Dobbins, CA 95935	GT	
<b>03c.</b>	<b>Biomass</b>	Rio Bravo Rocklin	3100 Thunder Valley Court, Lincoln CA 95648	GT	
		Honey Lake Power	732-025 Wendel Rd., Wendel, CA 96136	GT	
		Camptonville Community Partnership	11639 Marysville Road, Dobbins, CA 95935	GT	
		Woodland Biomass Power	1786 E Kentucky Ave, Woodland, CA 95776	GT	
		SRM-Energy Biomass Powerplant	20811 Industry Rd, Anderson, CA 96007	GT	

For the Sleighville Project in the state of California, federal prevailing wages **ARE** applicable to the following tasks:

<b>Item 6 – Road Reconstruction, Sleighville Roads Package</b>			
<b>Item #</b>	<b>Description</b>	<b>Unit of Measure</b>	<b>Quantity</b>
<b>06</b>	<b>Road Reconstruction</b>	<b>Mile</b>	<b>20.8</b>
<b>Road Number</b>	<b>Road Name</b>	<b>Approximate Distance (Miles)</b>	<b>Segment Price (\$)</b>
34	Jouberts	43 points over 12.06mi	
34-02	Pourier Creek	0.06	
34-02-01	Pourier Creek Spur	0.2	
34-03	Pourier Creek Spur	1.8	
34-04	Jouberts Spur	0.3	
34-05 Seg 1	Indian Hill North	0.18	
34-05 Seg 2	Indian Hill North	0.37	
34-06	Jouberts Spur	0.17	
34-07	Jouberts Spur	1.71	
34-07-01	Skinner Spur	0.2	
34-08	Upper Indian Creek	2.16	
34-09	Little Humbug	0.3	
34-09-01	Little Humbug Spur	0.46	
34-11	Twin Quartz Spur	0.3	
34-13-01	Twin Quartz Spur	0.53	
<b>TOTAL</b>		<b>20.8</b>	

**Total Bid**

Phase I – Tractor Units	
Phase II – Tractor Units	
Phase III – Cable Units	
Phase IV – Helicopter Units	
Item 6: Sleighville Roads Reconstruction	
<i>Grand Total</i>	

*For additional information, please review the Sleighville Road Maintenance Package in Appendix J.1 and Road Reconstruction Package in Appendix J.2.. Any costs associated with road maintenance should be included in Item 1: Commercial Thinning, for each phase. Coordination on road maintenance will be required for shared haul routes between Phases.*

### III. SUBMISSION, EVALUATION, AND CONTACTS

#### Contractor Selection Process

This is a request for proposals only and bids furnished in no way bind the National Forest Foundation. This request does not commit the National Forest Foundation to award any agreements nor to pay any costs incurred in the preparation or submission of the proposal or to contract for supplies or services.

The NFF will use the evaluation factors below to review each submitted bid. Each phase will be reviewed and scored for each of the below listed criteria. Bidders may be awarded one or multiple phases based on the individual phase scores. Based on the outcomes of the selection process, the NFF will notify successful and unsuccessful bidders within 20 business days of bid closing date. Contract documents will be prepared with the awarded Contractor(s) after notification.

#### Evaluation Factors and Relative Importance

The following criteria will be used in the evaluation of submitted proposals, ordered from highest weighting (level 3) to lowest weighting (level 1).

##### Level 3 Criteria

- Price / cost
- Technical proposal and proposed approach to project
- Equipment and contractor capability
- Past performance, references, and USFS feedback

##### Level 2 Criteria

- Timing of when contractor can begin and/or finish the project
- Overall strategic benefits to meeting NFF goals and grant needs, requirements, and timelines

##### Level 1 Criteria

- Relationship and benefits to the local community

#### Point of Contact

Please submit any questions about the project in writing to the point of contact.

Maggie Cummings  
National Forest Foundation Central Sierra Program Coordinator  
[mcummings@nationalforests.org](mailto:mcummings@nationalforests.org)

Responses will be shared with known interested parties by email or otherwise posted at <https://www.nationalforests.org/rfp>.

#### Bid Submission

Submit bids via email to Maggie Cummings at [mcummings@nationalforests.org](mailto:mcummings@nationalforests.org) by 5pm on April 11, 2025.

**Equal Opportunity Provider**

In accordance with Federal law and U.S. Department of Agriculture policy, the National Forest Foundation is prohibited from discriminating on the basis of race, color, national origin, sex, age, religion, political beliefs, or disability.

## Appendix A

**NFF Funding Code: 1596051**

**NFF Funding Name: SA SPA North Yuba Landscape Resilience Project  
(Inflation Reduction Act Funds)**

**Funder Agreement ID: 20-SA-11051700-020**

### Flowdown Provisions

#### **U.S. FOREST SERVICE ACKNOWLEDGED IN PUBLICATIONS, AUDIOVISUALS AND ELECTRONIC MEDIA.**

Award Recipient or Contractor shall acknowledge U.S. Forest Service support in any publications, audiovisuals, and electronic media developed as a result of this agreement.

#### **COPYRIGHTING.**

Award Recipient or Contractor is granted sole and exclusive right to copyright any publications developed as a result of this agreement. This includes the right to publish and vend throughout the world in any language and in all media and forms, in whole or in part, for the full term of copyright and all renewals thereof in accordance with this agreement. No original text or graphics produced and submitted by the U.S. Forest Service must be copyrighted. The U.S. Forest Service reserves a royalty-free, nonexclusive, and irrevocable right to reproduce, publish, or otherwise use, and to authorize others to use the work for Federal Government purposes.

This right must be transferred to any sub-agreements or subcontracts.

This provision includes:

- The copyright in any work developed by Award Recipient or Contractor under this agreement.
- Any right of copyright to which Award Recipient or Contractor purchase(s) ownership with any Federal contributions.

USDA-FOREST SERVICE  
TAHOE NATIONAL FOREST  
YUBA RIVER RANGER DISTRICT  
SLEIGHVILLE TIMBER SALE  
Sale Area and Road Maintenance Map

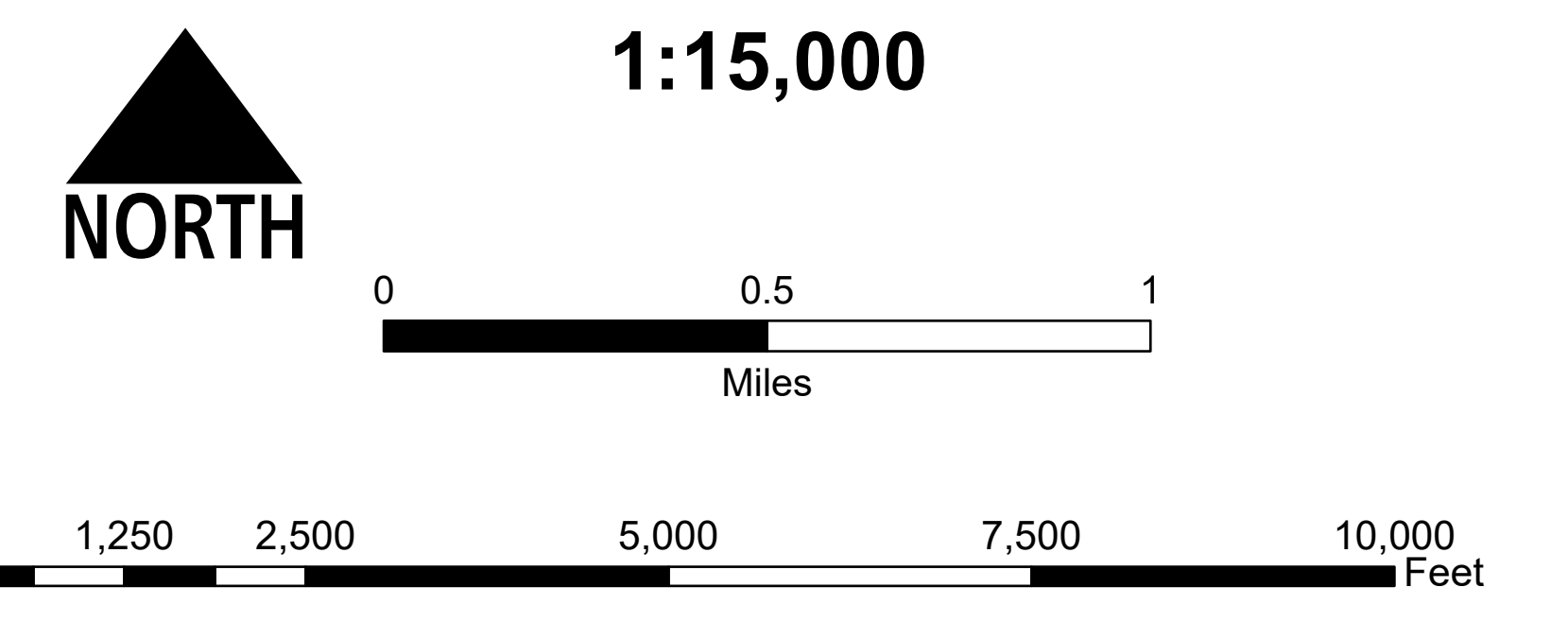

Map Legend

- Sale Area Boundary - G.1
- Phase I Tractor Subdivision Boundary - G.1
- Phase II Tractor Subdivision Boundary - G.1
- Phase III Cable Subdivision Boundary - G.1
- Phase IV Helicopter Subdivision Boundary - G.1
- Unit Subdivision Label - G.1
- Road Number - G.1
- Existing Transportation Road System - G.1
- Haul Direction - G.1
- Existing Gate/Barricade to Protect - G.1
- Road Reconstruction - F.10
- Proposed Temporary Road - F.10
- Existing Temporary Road - F.10
- Other Ownership - G.1
- Known Survey Monument to Protect - F.9
- Powerline
- Water Source - F.9
- Spring to Protect, (100' Equipment Exclusion, 300' No Main Skid Trails) - E
- Ephemeral Streamcourse to Protect - (30' Equipment Exclusion, 150' No Main Skid Trails) (Block Marks Upper Limit) - E
- Intermittent Streamcourse to Protect - (50' Equipment Exclusion, 150' No Main Skid Trails) (Block Marks Upper Limit) - E
- Perennial Streamcourse to Protect - (100' Equipment Exclusion, 300' No Main Skid Trails) (Block Marks Upper Limit) - E
- National FS Trails
- Spotted Owl LOP Mar 15-Aug 15
- Goshawk LOP Feb 15-Sept 15
- Restricted Flight Path
- Boundary Lines Surveyed 2024

Requirements Legend

- ASTR - Additional Slash Treatment Requirements - F.9
- COVER - Cover Logging Slash Piles - F.9
- DECK - Deck Large Material (Landings) - F.9
- DF - Directional Felling Required - F.9
- D&P - Designation by Prescription - F.9
- ENDL - Endling to Protect Resources - F.9
- FELL - Fell Damaged Trees - F.9
- ITM - Individual Tree Mark - F.7
- KO - Keep Roads and Trails Open - G.24
- MACH - Machine Pile Logging Slash (Landings) - F.9
- MAX - 144' - Ground Based Skidding (Rubber Tired) - F.9
- SEPM - Maximum Log Length - F.9
- SEPM - Minimum Stump Height - F.9
- NO LOP - No Limiting - F.9
- RM - Road Maintenance - F.10b
- NO LOP - Specified Erosion Prevention Measures - F.9
- SCAT - Scatter Logging Slash - F.9
- SOS - State Operations Schedule - F.9
- SPACE - Ground Based Skidding (Skid Trail Spacing) - F.9
- SRS - Skyline Required - F.9
- SUSP - Ground Based Skidding (One end suspension) - F.9
- TILL - Tillage - F.9
- TRAC - Tractor Skidding Specified - F.9
- W - Dust Abatement (Water) - F.10
- WHOLE - Whole Tree Yarding - F.9

Subdivision Requirements

Subdivision	Requirements
Phase I Tractor (TM) - 1, 16, 30, 33, 35, 43, 75, 102, 108, 118, 135, 138, 142, 150	ASTR: DF: D&P: FELL: MAX: 144'; Minimum Log Length: Minimum Stump Height: MH: NO LOP: SCAT: 10'; SEPM: SOS, SPACE, SUSP: TELL: TRAC: TS, WHOLE, ENCL.
Phase I Tractor (TM) - 172, 187, 189, 190, 193, 200, 201, 212, 215, 229, 230, 232, 234, 242, 244, 245, 248, 257, 271, 279, 283, 345, 445	ASTR: DF: D&P: FELL: MAX: 144'; Minimum Log Length: Minimum Stump Height: MH: NO LOP: SCAT: 10'; SEPM: SOS, SPACE, SUSP: TELL: TRAC: TS, WHOLE, ENCL.
Phase II Tractor (TM) - 90, 96, 190, 146, 169, 151, 154, 141, 542	ASTR: DF: D&P: FELL: MAX: 144'; Minimum Log Length: Minimum Stump Height: MH: NO LOP: SCAT: 10'; SEPM: SOS, SPACE, SUSP: TELL: TRAC: TS, WHOLE, ENCL.
Phase II Tractor (TM) - 28, 33, 35, 37, 172, 175, 190, 204, 205, 213, 225, 226, 247, 248, 252, 255, 272, 284, 287, 288, 313, 314, 323, 334, 345, 348, 438, 439	ASTR: DF: D&P: FELL: MAX: 144'; Minimum Log Length: Minimum Stump Height: MH: NO LOP: SCAT: 10'; SEPM: SOS, SPACE, SUSP: TELL: TRAC: TS, WHOLE, ENCL.
Phase II Cable (TM) - 11, 51, 91, 91, 101	ASTR: DF: D&P: FELL: MAX: 144'; Minimum Log Length: Minimum Stump Height: MH: NO LOP: SCAT: 10'; SEPM: SOS, SPACE, SUSP: TELL: TRAC: TS, WHOLE, ENCL.
Phase II Cable (TM) - 128, 155, 167, 167, 174, 184, 186, 191, 201, 208, 239, 241, 242, 252, 255, 264, 265, 266, 267, 272, 279, 286, 310, 320, 342, 345, 371, 383, 385, 430, 434, 439, 440, 501, 506, 460, 77	ASTR: DF: D&P: FELL: MAX: 144'; Minimum Log Length: Minimum Stump Height: MH: NO LOP: SCAT: 10'; SEPM: SOS, SPACE, SUSP: TELL: TRAC: TS, WHOLE, ENCL.
Phase IV Helicopter (TM) - 316, 631	ITM: ASTR: DF: FELL: MAX: 144'; Minimum Log Length: Minimum Stump Height: MH: NO LOP: SCAT: 10'; SEPM: SOS, SPACE, SUSP: TELL: TRAC: TS, WHOLE, ENCL.

Landings

Landings	Requirements
ALL	COVER, DECK, MACH, TILL

Road Requirements

Phase	Road	Requirements	Phase	Road	Requirements
I	293-02 Seg 1	KO, RM, W	III	34-02 Seg 1	KO, RM, W
I	293-02 Seg 2	KO, RM, W	III	34-02 Seg 2	KO, RM, W
I	293-02-02	KO, RM, W	III	34-02-01	KO, RM, W
II, III	293-18	KO, RM, W	III	34-07	KO, RM, W
II, III	288-18-65-01	KO, RM, W	III	34-08-02	KO, RM, W
II, III	293-15-06	KO, RM, W	III	34-02-02	KO, RM, W
II, III	34-28-03	KO, RM, W	III	34-02-01	KO, RM, W
III	34-13	KO, RM, W	III	34-08-02	KO, RM, W
III	34-15	KO, RM, W	III	34-07-01	KO, RM, W
III	34-15-01	KO, RM, W	III	34-09	KO, RM, W
I	49-22	KO, RM, W	III	34-09-01	KO, RM, W
I, II, III	34	KO, RM, W	III	34-11	KO, RM, W
I	34-01 Seg 1	KO, RM, W	III	34-13-01	KO, RM, W
I	34-02	KO, RM, W	III	34-08 Seg 2	KO, RM, W
I	34-03 Seg 1	KO, RM, W	III	293-02-03	KO, RM, W
I	34-03 Seg 2	KO, RM, W	III	34-12	KO, RM, W
I	38-04	KO, RM, W	III	293-02-02-02	KO, RM, W

Traffic Control Plan Necessary for Operation on or Adjacent to National Forest Roads or Trails - G.5  
Cleaning of Equipment Required Prior to Entering Sale Area - G.11  
Remote Automated Weather Station T.N.F. Westside Group  
Special Erosion Prevention Measures - 15 Acres - F.9, G.23  
Tillage Required - Not To Exceed 400 acres - F.9  
Contour Interval - 80 feet  
Landlines are approximate



## Appendix E Service Work Items and Specifications

The Sleighville Project has been subdivided into four phases based on yarding method and location of units. Each phase is summarized below, and the units within each phase are listed in Table 7: Service Items by Unit. Contractors may bid on one phase or multiple phases and must bid on all items within the phase in which they are bidding.

Table 1: Phase I Schedule of Service Work

<b>Phase I: Tractor Based Units</b>					
Item #	Description	Unit of Measure	Quantity	Unit Cost (\$)	Extended Cost (\$)
<b>01</b>	<b>Commercial Thinning (Includes up to 16.6 miles of road maintenance)</b>	<b>Acre</b>	<b>1,291.1</b>		
<b>02</b>	<b>Small Tree Thinning</b>	<b>Acre</b>	<b>1,291.1</b>		
a.	Machine Cut and Remove to Landing	Acre	1,291.1		
<b>03</b>	<b>Wood Product Processing and Transportation</b>	<b>GT</b>	<b>119,711</b>		
a.	Saw Timber*	GT	81,357		
b.	Non-saw Timber*	GT	9,454		
c.	Biomass (tops/limbs/slash/remove to landing)*	GT	28,900		
<b>04.</b>	<b>Temporary Road Construction</b>	<b>Mile</b>	<b>2.9</b>		
<b>05.</b>	<b>Water Draft Site Development AND/OR Water Purchasing</b>	<b>Draft Site</b>	<b>3</b>		
		<b>Lump Sum</b>	<b>1</b>		
<b>Phase I Total</b>					

\* Enter the highest unit cost from Table 5: Wood Processing Receiving Facilities to calculate the extended cost for Items 3a, 3b, and 3c.

Table 2: Phase II Schedule of Service Work

<b>Phase II: Tractor Based Units</b>					
Item #	Description	Unit of Measure	Quantity	Unit Cost (\$)	Extended Cost (\$)
<b>01</b>	<b>Commercial Thinning (Includes up to 18 miles of road maintenance)</b>	<b>Acre</b>	<b>969.4</b>		
<b>02</b>	<b>Small Tree Thinning</b>	<b>Acre</b>	<b>679.7</b>		
a.	Machine Cut and Remove to Landing	Acre	679.7		
<b>03</b>	<b>Wood Product Processing and Transportation</b>	<b>GT</b>	<b>95,272</b>		
a.	Saw Timber*	GT	70,636		
b.	Non-saw Timber*	GT	7,986		
c.	Biomass (tops/limbs/slash/remove to landing)*	GT	16,650		

<b>04.</b>	<b>Temporary Road Construction</b>	<b>Mile</b>	<b>2.7</b>		
<b>05.</b>	<b>Water Draft Site Development AND/OR Water Purchasing</b>	<b>Draft Site</b>	<b>4</b>		
		<b>Lump Sum</b>	<b>1</b>		
<b>Phase II Total</b>					

\* Enter the highest unit cost from Table 5: Wood Processing Receiving Facilities to calculate the extended cost for Items 3a, 3b, and 3c.

Table 3: Phase III Schedule of Service Work

<b>Phase III: Cable Units</b>					
<b>Item #</b>	<b>Description</b>	<b>Unit of Measure</b>	<b>Quantity</b>	<b>Unit Cost (\$)</b>	<b>Extended Cost (\$)</b>
<b>01</b>	<b>Commercial Thinning (Includes up to 20.3 miles of road maintenance)</b>	<b>Acre</b>	<b>1,110.3</b>		
a.	Cable	Acre	1,106.3		
b.	Tractor	Acre	3.9		
<b>02</b>	<b>Small Tree Thinning</b>	<b>Acre</b>	<b>88.1</b>		
a.	Machine Cut and Remove to Landing	Acre	3.9		
b.	Hand Cut/Hand Pile	Acre	84.2		
<b>03</b>	<b>Wood Product Processing and Transportation</b>	<b>GT</b>	<b>100,532</b>		
a.	Saw Timber*	GT	68,524		
b.	Non-saw Timber*	GT	7,008		
c.	Biomass (tops/limbs/slash/remove to landing)*	GT	25,000		
<b>04.</b>	<b>Temporary Road Construction</b>	<b>Mile</b>	<b>1.2</b>		
<b>05.</b>	<b>Water Draft Site Development AND/OR Water Purchasing</b>	<b>Draft Site</b>	<b>3</b>		
		<b>Lump Sum</b>	<b>1</b>		
<b>Phase III Total</b>					

\* Enter the highest unit cost from Table 5: Wood Processing Receiving Facilities to calculate the extended cost for Items 3a, 3b, and 3c.

Table 4: Phase IV Schedule of Service Work

<b>Phase IV: Helicopter Units</b>					
<b>Item #</b>	<b>Description</b>	<b>Unit of Measure</b>	<b>Quantity</b>	<b>Unit Cost (\$)</b>	<b>Extended Cost (\$)</b>
<b>01</b>	<b>Commercial Thinning</b>	<b>Acre</b>	<b>171.80</b>		
<b>03</b>	<b>Wood Product Processing and Transportation</b>	<b>GT</b>	<b>11,563</b>		
a.	Saw Timber*	GT	10,508		
b.	Non-saw Timber*	GT	1,055		
<b>Phase IV Total</b>					

\* Enter the highest unit cost from Table 5: Wood Processing Receiving Facilities to calculate the extended cost for Items 3a and 3b.

Table 5: Wood Processing Receiving Facilities

<b>Wood Processing Receiving Facilities</b>					
<b>Item #</b>	<b>Description</b>	<b>Receiving Facility</b>	<b>Delivery Address</b>	<b>Unit of Measure</b>	<b>Unit Cost (\$)</b>
<b>03a.</b>	<b>Saw Timber</b>	SPI – Lincoln	1445 California 65, Lincoln, CA 95648	GT	
		SPI - Quincy	1538 Lee Road, Quincy, CA 5971	GT	
		SPI – Oroville	3025 South 5th Avenue, Oroville, CA, 95965	GT	
		Trinity River Lumber Co	Receiving facility: 3000 S 7th Ave. Oroville, Ca 95965	GT	
		Mendicino Forest Products LLC	Receiving facility: 4341 Chippewa Trail, Marysville, CA 95901	GT	
		Tahoe Forest Products	3736 Vista Grande Blvd, Carson City, NV 89705	GT	
		Camptonville Community Partnership	11639 Marysville Road, Dobbins, CA 95935	GT	
		Timber Products Company	130 North Phillipe Lane, Yreka, CA 96097	GT	
		Roseburg Forest Products	98 Mill Street, Weed, CA 96094	GT	
		Sierra Valley Enterprises LLC	100 Railroad Ave, Loyalton, CA 96118	GT	
		Alpenglow Timber	Klondike Flat Rd, Truckee, CA 96161	GT	
<b>03b.</b>	<b>Non-saw Timber</b>	Washoe Tribe Wood for Elders Gardnerville, NV	919 U.S. Hwy 395 N, Gardnerville, NV 89410	GT	
		Camptonville Community Partnership	11639 Marysville Road, Dobbins, CA 95935	GT	
<b>03c.</b>	<b>Biomass</b>	Rio Bravo Rocklin	3100 Thunder Valley Court, Lincoln CA 95648	GT	
		Honey Lake	732-025 Wendel Rd., Wendel, CA 96136	GT	
		Camptonville Community Partnership	11639 Marysville Road, Dobbins, CA 95935	GT	
		Woodland Biomass Power	1786 E Kentucky Ave, Woodland, CA 95776	GT	
		SRM-Energy Biomass Powerplant	20811 Industry Rd, Anderson, CA 96007	GT	

Table 6: Sleighville Roads Package

<b>Item 6: Road Reconstruction</b>			
<b>Road Segment</b>	<b>Road Name</b>	<b>Approximate Distance (Miles)</b>	<b>Segment Price (\$)</b>

<b>Item 6: Road Reconstruction</b>			
34	Jouberts	43 points over 12.06mi	
34-02	Pourier Creek	0.06	
34-02-01	Pourier Creek Spur	0.2	
34-03	Pourier Creek Spur	1.8	
34-04	Jouberts Spur	0.3	
34-05 Seg 1	Indian Hill North	0.18	
34-05 Seg 2	Indian Hill North	0.37	
34-06	Jouberts Spur	0.17	
34-07	Jouberts Spur	1.71	
34-07-01	Skinner Spur	0.2	
34-08	Upper Indian Creek	2.16	
34-09	Little Humbug	0.3	
34-09-01	Little Humbug Spur	0.46	
34-11	Twin Quartz Spur	0.3	
34-13-01	Twin Quartz Spur	0.53	

Table 7: Service Items by Unit

Unit	Acres	Item 1: Commercial Thinning		Item 2a: Small Tree – Machine cut, remove to landing	Item 2b: Small Tree – Hand cut/Hand Pile	Item 3a: Wood Processing and Transportation - Sawtimber	Item 3b: Wood Processing and Transportation - Non-saw	Item 3c: Wood Processing and Transportation - Biomass	Item 4: Temp Road Construction
		DxP	ITM						
Phase I – Tractor based units									
7	36.20	X		X		X	X	X	
10	44.90	X		X		X	X	X	X
30	17.85	X		X		X	X	X	
32	19.67	X		X		X	X	X	
60	18.20	X		X		X	X	X	X
63	28.19	X		X		X	X	X	
75	12.80	X		X		X	X	X	
102	17.67	X		X		X	X	X	
108	52.30	X		X		X	X	X	X
118	12.36	X		X		X	X	X	X
130	29.40	X		X		X	X	X	
138	28.20	X		X		X	X	X	
147	9.60	X		X		X	X	X	
150	13.10	X		X		X	X	X	X
173	9.34		X	X		X	X	X	X
182	7.05		X	X		X	X	X	
187	3.72		X	X		X	X	X	
189	33.97		X	X		X	X	X	X
190	23.30		X	X		X	X	X	X
193	90.60		X	X		X	X	X	X
200	12.70		X	X		X	X	X	
207	23.50		X	X		X	X	X	
212	14.90		X	X		X	X	X	
216	12.60		Ad vol	X		X	X	X	X
229	34.50		X	X		X	X	X	X

Unit	Acres	Item 1: Commercial Thinning		Item 2a: Small Tree – Machine cut, remove to landing	Item 2b: Small Tree – Hand cut/Hand Pile	Item 3a: Wood Processing and Transportation - Sawtimber	Item 3b: Wood Processing and Transportation - Non-saw	Item 3c: Wood Processing and Transportation - Biomass	Item 4: Temp Road Construction
		DxP	ITM						
230	8.70		X	X		X	X	X	
232	83.30		Ad vol	X		X	X	X	X
234	65.40		X	X		X	X	X	
242	74.80		X	X		X	X	X	X
244	5.90		X	X		X	X	X	X
245	65.60		X	X		X	X	X	
248	55.40		X	X		X	X	X	
257	35.30		X	X		X	X	X	X
271	151.00		X	X		X	X	X	X
379	13.30		X	X		X	X	X	
384	15.40		X	X		X	X	X	X
386	17.20		X	X		X	X	X	X
445	93.20		Ad vol	X		X	X	X	
Phase I total	1291.1								
Phase II – Tractor based units									
28	19.10		X	X		X	X	X	X
31	6.40		Ad vol	X		X	X	X	X
33	13.50		Ad vol	X		X	X	X	
53	13.9		Ad vol			X	X		
90	22.80	X				X	X		
96	36.80	X		X		X	X	X	X
110	14.20	X		X		X	X	X	
146	26.40	X		X		X	X	X	
149	44.99	X				X	X		
151	49.90	X		X		X	X	X	X
154	29.50	X				X	X		X

Unit	Acres	Item 1: Commercial Thinning		Item 2a: Small Tree – Machine cut, remove to landing	Item 2b: Small Tree – Hand cut/Hand Pile	Item 3a: Wood Processing and Transportation - Sawtimber	Item 3b: Wood Processing and Transportation - Non-saw	Item 3c: Wood Processing and Transportation - Biomass	Item 4: Temp Road Construction
		DxP	ITM						
170	5.90		X	X		X	X	X	
172	13.60		X	X		X	X	X	
179	9.70		X	X		X	X	X	
180	11.30		X	X		X	X	X	X
204	41.73		X	X		X	X	X	
205	15.80		X	X		X	X	X	
213	25.90		X	X		X	X	X	X
215	40.30		X	X		X	X	X	
235	9.30		X	X		X	X	X	X
236	20.10		X	X		X	X	X	
247	17.30		X	X		X	X	X	X
259	5.30		X	X		X	X	X	X
262	11.20		X	X		X	X	X	
269	23.30		X	X		X	X	X	
273	9.40		X	X		X	X	X	
294	3.20		X			X	X		
307	1.50		X	X		X	X	X	
308	7.30		X			X	X		
313	32.40		X	X		X	X	X	X
314	19.80		X	X		X	X	X	
322	18.60		X			X	X		
323	17.70		X			X	X		X
344	41.40		X	X		X	X	X	X
346	5.30		X			X	X		
349	41.40		X			X	X		
436	52.20		X	X		X	X	X	X
438	33.50		X	X		X	X	X	

Unit	Acres	Item 1: Commercial Thinning		Item 2a: Small Tree – Machine cut, remove to landing	Item 2b: Small Tree – Hand cut/Hand Pile	Item 3a: Wood Processing and Transportation - Sawtimber	Item 3b: Wood Processing and Transportation - Non-saw	Item 3c: Wood Processing and Transportation - Biomass	Item 4: Temp Road Construction
		DxP	ITM						
442	11.00		X	X		X	X	X	
444	28.20		X	X		X	X	X	X
446	24.00		X	X		X	X	X	X
447	9.30		X	X		X	X	X	
541	60.10	X				X	X		X
542	24.90	X				X	X		
Phase II total	969.4								
Phase III – Cable Units									
11	11.00	X			X	X	X		X
57	3.40	X			X	X	X		
91	12.50	X				X	X		
97	16.60	X			X	X	X		
101	3.92	X		X		X	X	X	
128	12.40		Ad vol			X	X		
155	5.30		X			X	X		
167	29.60		X			X	X		
169	19.10		X		X	X	X		X
171	84.80		X			X	X		X
184	32.20		X			X	X		
186	14.70		X			X	X		
191	4.60		X			X	X		
201	22.40		X			X	X		
208	23.10		X			X	X		
239	19.80		X			X	X		X
241	143.10		X			X	X		X
246	59.60		X			X	X		



Unit	Acres	Item 1: Commercial Thinning		Item 2a: Small Tree – Machine cut, remove to landing	Item 2b: Small Tree – Hand cut/Hand Pile	Item 3a: Wood Processing and Transportation - Sawtimber	Item 3b: Wood Processing and Transportation - Non-saw	Item 3c: Wood Processing and Transportation - Biomass	Item 4: Temp Road Construction
		DxP	ITM						
252	62.00		X			X	X		
260	15.80		X			X	X		X
264	3.60		X			X	X		
265	24.80		X			X	X		
266	76.15		X			X	X		X
267	11.00		X			X	X		
272	1.60		X			X	X		
275	12.20		X			X	X		
278	13.20		X			X	X		
286	2.10		X			X	X		
319	47.30		X			X	X		
320	10.50		X			X	X		
342	43.70		X			X	X		
345	5.60		X			X	X		
371	28.10		X			X	X		
383	12.90		X		X	X	X		
385	2.20		X			X	X		X
430	22.70		X			X	X		X
434	27.60		X			X	X		
435	21.20		X		X	X	X		
457	20.00		X			X	X		X
551	27.80		X			X	X		
552	27.30		X			X	X		X
666	52.00		X			X	X		
777	20.80		X			X	X		
Phase III total	1,110.2								

Unit	Acres	Item 1: Commercial Thinning		Item 2a: Small Tree – Machine cut, remove to landing	Item 2b: Small Tree – Hand cut/Hand Pile	Item 3a: Wood Processing and Transportation - Sawtimber	Item 3b: Wood Processing and Transportation - Non-saw	Item 3c: Wood Processing and Transportation - Biomass	Item 4: Temp Road Construction
		DxP	ITM						
<b>Phase IV: Helicopter Units</b>									
316	134.50		X			X	X		
431	37.30		X			X	X		
Phase IV total	171.8								

## Item 1: Commercial Thinning

All timber meeting the specifications in Appendix F are to be removed utilizing the methods and requirements contained therein. The provisions below outline the permissible systems for each treatment designation type. Each phase includes road maintenance applicable to roads used to complete the phase. The Contractor is authorized to maintain roads, bridges, and other transportation facilities, as needed for conducting treatments on National Forest lands. Maintenance plans consist of, but are not limited to, ditch cleaning, surface blading, drainage structures, dust abatement, roadside vegetation, waterbars, and barriers. Specified road maintenance requirements are in Appendix F (Section F- 10a/b) and in the Sleighville Road Maintenance Package. Securing County Road encroachment permits is the responsibility of the awarded contractor.

### a. Tractor

1. Ground-based tractor systems shall be used on slopes less than 40%. Ground-based tractor systems are permissible on slopes 40-50% if tethered. Adverse skidding permissible on slopes up to 25%. Forest Service may approve steeper pitches of adverse skidding less than 100 feet. Approval will be granted in writing within 181 documentation.
2. Phase I:
  - A. Plantation DxP – 340.4 acres: Units 7, 10, 30, 32, 60, 63, 75, 102, 108, 118, 130, 138, 147, 150
  - B. Mixed conifer ITM – 950.7 acres: Units 173, 182, 187, 189, 190, 193, 200, 207, 212, 216, 229, 230, 232, 234, 242, 244, 245, 248, 257, 271, 379, 384, 386, 445
3. Phase II:
  - A. Plantation DxP – 309.6 acres: Units 90, 96, 110, 146, 149, 151, 154, 541, 542
  - B. Mixed conifer ITM – 660.0 acres: Units 28, 31, 33, 53, 170, 172, 179, 180, 204, 205, 213, 215, 235, 236, 247, 259, 262, 269, 273, 294, 307, 308, 313, 314, 322, 323, 344, 346, 349, 436, 438, 442, 444, 446, 447
4. Phase III:
  - A. Plantation DxP – 4 acres: Unit 101

### b. Cable, or other aerial based systems

1. Cutting and felling of trees will be accomplished by hand with a chainsaw or mechanically using rubber-tired or track-mounted feller buncher or cut-to-length harvester. On slopes over 40%, these machines would be tethered to a cable to minimize soil disturbance.
2. Skyline or cable yarding systems shall be used on slopes greater than 40%.
3. Phase III:
  - A. Plantation DxP – 43.5 acres: Units 11, 57, 91, 97
  - B. Mixed conifer ITM – 1,062.9 acres: Units 128, 155, 167, 169, 171, 184, 186, 191, 201, 208, 239, 241, 246, 252, 260, 264, 265, 266, 267, 272, 275, 278, 286, 319, 320, 342, 345, 371, 383, 385, 430, 434, 435, 457, 551, 552, 666, 777

### c. Helicopter

1. Cutting and felling of trees will be accomplished by hand with a chainsaw, and

yarding shall be by a helicopter capable of lifting and transporting products to landings without unnecessary damage to residual trees.

2. Phase IV

B. Mixed conifer ITM – 171.8 acres: Units 316, 431

## Item 2: Small Tree Thinning

- a. Machine Cut and Remove to Landing: machine cut conifers and brush 3 – 9.9 inches diameter at breast height (DBH) and surface fuels following the specifications below. Remove all cut material 3-9.9 inches DBH to landings for processing. Conifers and brush 1-2.9 inches DBH will remain on site and be dispersed to reduce fuel loading at a depth less than 18 inches.

1. Machine Cut:

- A. Mechanical removal of small trees and brush 3 – 9.9 inches DBH and surface fuels to reduce surface and ladder fuels.
- B. Conifer trees and brush up 3 – 9.9 inches DBH, un-utilizable conifers (e.g., 10 to 16 inches DBH), and surface fuels will be cut concurrent with commercial harvest in units where operationally feasible.
- C. Leave 20 healthy trees under 10 inches DBH per acre (approximately 45- 50' spacing) of varying size.
- D. Selection of Leave Trees: In general, priority for tree retention should be based on health of the tree, then the preferred tree species, and then the size of the trees. This will allow for structural variability while leaving the healthiest trees available. Leave trees shall generally be those of the straightest boles that are free of damage due to insects, disease, physical and mechanical causes. The Contractor shall select leave tree using the following priorities:
  - 1. Space residual trees 45-50 feet apart between boles. Select leave trees from healthy, undamaged hardwoods and conifers. Hardwoods will supersede conifers when leaving a healthy leave tree. Spacing will supersede the diameter limit when setting priority of treatment.
  - 2. Selected leave trees should be the best formed, disease free, insect free, and damage free trees available. Leaving slightly damaged trees when these are the best available to meet spacing requirements is acceptable.
  - 3. Species retention is (in order of preference): hardwoods, Jeffrey Pine/Ponderosa Pine, Sugar Pine, Douglas Fir, Incense Cedar, White Fir.
  - 4. Avoid damaging and retain big leaf maple, elderberry, dogwood, Pacific yew, and California Hazelnut.
  - 5. Hardwoods (except tanoak) greater than 4 inches DBH will not be removed except to allow for operability or safety. Individual trees and pockets of smaller hardwoods may be flagged for avoidance during operations.
    - a. Tanoak DBH limit is 12 inches. A maximum spacing of 25 feet between residual trees. Tanoak under 12 inches DBH may be left to meet spacing requirements.
    - b. Remove conifers within 25 feet of the bole and dripline of black oak greater than or equal to 12 inches DBH and a

healthy crown. This applies to individuals or multi-stemmed clumps. Remove all conifers within 25 feet of oaks growing in cluster regeneration.

6. Leave all alders and other riparian vegetation within and adjacent to stream beds (wet or dry). Conifer and other brush species (manzanita, whitethorn) will be removed from these areas if below hydrology specifications allow.
  7. Cut stumps of trees and brush so that they are no more than 4 inches in height on the high side of the stump. Make the residual stand easy to walk through and cut stumps low so they are not a tripping hazard.
- E. Selection of Cut Trees:
1. Where no overstory trees exist over 10 inches DBH, thin trees to an average 25 foot spacing and cut all remaining vegetation per specifications.
  2. Where an overstory exists, cut all un-utilizable conifers 10-16 inches DBH and conifer trees 3 – 9.9 inches DBH that do not meet the definition of a leave tree while observing spacing requirements, except those specified to be left within each designated unit.
  3. Snags: Snags less than 10 inches DBH will be cut and removed to landing per specifications. Hazardous trees or snags greater than 24 inches DBH will be felled and left to recruit large down woody debris up to levels identified as the desired condition for the area. Fallen trees/snags will not be bucked up into small pieces but will be retained as whole logs or large pieces, where feasible. The four largest snags will be retained per acre. Select the largest snags that do not pose a hazard to operations or public safety.
- F. 3-10 tons/acre of the largest down woody material available will be left on site. Where feasible, retain down wood that is:
1. Outside of the dripline of remaining live trees.
  2. In contact with the soil.
  3. Left un-bucked.
  4. Wood that is so rotten it cannot support itself will be left and counted towards down woody requirements.
  5. Hazardous trees and snags may also be felled and left whole to contribute to down woody requirements.
- G. Remaining supportable dead and downed wood will be removed to landings.
- H. Treatment of Brush
1. All woody brush up 3 – 9.9 inches DBH within the work areas shall be cut except for hazelnut and noxious weeds. Brush does not include herbaceous material. All brush treated shall be cut within 4 inches of the ground or 4 inches of obstacles (i.e. rocks, down logs) and no leaves shall remain attached to the portion remaining in the ground.
  2. Brush that is not feasible to cut shall be left on site and destroyed to reduce fuel loading at a depth less than 18 inches.
- I. See Appendix G for general resource management and flagging requirements.

- J. See harvest cards for specific unit resource management requirements.
- 2. Remove to landing
  - A. When feasible within the cutting units, the Contractor shall transport from Project Area all cut conifers and brush 3-9.9 inches DBH and surface fuels to identified landings.
    - 1. Downed logs shall be transported to a designated landing unless identified, by a designated representative, to remain in Project Area for resource utilization.
    - 2. If a standing tree has been identified, by a designated representative, to remain on site after felling or is unable to be transported until a later time, the bole of the tree needs to be grounded, limbed, slash removed and left.
    - 3. Do not cause ground disturbance, except along designated skid trail routes previously approved and flagged.
    - 4. Limit off-road vehicle/equipment use.
    - 5. Haul all slash material offsite to identified Disposal Sites and pile slash on landing(s). Slash shall not be deposited within controlled areas.
  - B. Material 1-2.9 inches DBH will remain on site and be dispersed to reduce fuel loading at a depth less than 18 inches
  - C. During landing close out, if slash material cannot be moved to identified disposal sites, and must be left piled, the deck shall be flipped and prepared for burning. A fire line 12 feet wide around the deck must be cleared of flammable material. The outer 18 inches of the fire line must be dug down to bare mineral soil. A sheet of 6mm thick plastic 10 feet wide by 10 feet long must be secured on a south to southwest facing side of the deck to allow for dry ignition.
- b. Hand Cut/Hand Pile: Conifer trees and brush up 3 – 9.9 inches DBH and surface fuels will be cut concurrent with commercial harvest units and piled.
  - 1. Hand Cut
    - A. Manual removal of small trees and brush 3 – 9.9 inches DBH and surface fuels to reduce surface and ladder fuels. Pruning of trees will occur to increase canopy base heights. This would reduce the risk of prescribed fire or wildfire fire moving into the tree crowns.
    - B. Conifer trees and brush 3 – 9.9 inches DBH, un-utilizable conifers (e.g., 10 to 16 inches DBH), and surface fuels will be cut concurrent with commercial harvest in units where operationally feasible.
    - C. Leave 20 healthy trees under 10 inches DBH per acre (approximately 45- 50' spacing) of varying size.
    - D. Selection of Leave Trees: In general, priority for tree retention should be based on health of the tree, then the preferred tree species, and then the size of the trees. This will allow for structural variability while leaving the healthiest trees available. Leave trees shall generally be those of the straightest boles that are free of damage due to insects, disease, physical and mechanical causes. The Contractor shall select leave tree using the following priorities:
      - 1. Space residual trees 45-50 feet apart between boles. Select leave trees from healthy, undamaged hardwoods and conifers. Hardwoods will supersede conifers when leaving a healthy leave tree. Spacing will supersede the diameter limit when setting priority

of treatment.

2. Selected leave trees should be the best formed, disease free, insect free, and damage free trees available. Leaving slightly damaged trees when these are the best available to meet spacing requirements is acceptable.
  3. Species retention is (in order of preference): hardwoods, Jeffrey Pine/Ponderosa Pine, Sugar Pine, Douglas Fir, Incense Cedar, White Fir.
  4. Avoid damaging and retain big leaf maple, elderberry, dogwood, Pacific yew, and California Hazelnut.
    - a. Hardwoods (except tanoak) greater than 4 inches DBH will not be removed except to allow for operability or safety. Individual trees and pockets of smaller hardwoods may be flagged for avoidance during operations.
    - b. Tanoak DBH limit is 12 inches. A maximum spacing of 25 feet between residual trees. Tanoak under 12 inches DBH may be left to meet spacing requirements.
    - c. Remove conifers within 25 feet of the bole and dripline of black oak greater than or equal to 12 inches DBH and a healthy crown. This applies to individuals or multi-stemmed clumps.
    - d. Small black oaks and tanoak in cluster regeneration should be thinned to the best 2-3 stems. Remove all conifers within 25 feet of clusters.
  5. Leave all alders and other riparian vegetation within and adjacent to stream beds (wet or dry). Conifer and other brush species (manzanita, whitethorn) will be removed from these areas if below hydrology specifications allow.
  6. Cut stumps of trees and brush so that they are no more than 4 inches in height on the high side of the stump.
- E. Selection of Cut Trees:
1. Where no overstory trees exist over 10 inches DBH, thin trees to an average 25 foot spacing and cut all remaining vegetation per specifications.
  2. Where an overstory exists, cut all un-utilizable conifers 10-16 inches DBH and conifer trees less than 10 inches at DBH that do not meet the definition of a leave tree while observing spacing requirements, except those specified to be left within each designated unit.
  3. Snags: Snags less than 10 inches DBH will be cut and removed to landing per specifications. Hazardous trees or snags greater than 24 inches DBH will be felled and left to recruit large down woody debris up to levels identified as the desired condition for the area. Fallen trees/snags will not be bucked up into small pieces but will be retained as whole logs or large pieces, where feasible. The four largest snags will be retained per acre. Select the largest snags that do not pose a hazard to operations or public safety.
- F. 3-10 tons/acre of the largest down woody material available will be left on site. Where feasible, retain down wood that is:
1. Outside of the dripline of remaining live trees.

2. In contact with the soil.
  3. Left un-bucked.
  4. Wood that is so rotten it cannot support itself will be left and counted towards down woody requirements. Hazardous trees and snags may also be felled and left whole to contribute to down woody requirements.
- G. Existing dead and down material 1 - 12 inches DBH will be cut into sections no longer than 4 feet and piled. Dead and downed material greater than 12 inches DBH will be left. Remaining dead and downed material greater than 12 inches DBH may exceed 10 tons.
- H. Treatment of Brush
1. All woody brush up 3 – 9.9 inches DBH within the work areas shall be cut except for hazelnut and noxious weeds. Brush does not include herbaceous material. All brush treated shall be cut within 4 inches of the ground or 4 inches of obstacles (i.e. rocks, down logs) and no leaves shall remain attached to the portion remaining in the ground.
- I. Pruning
1. All leave trees shall be pruned of lateral branches to at least 6 feet from the ground or 2/3 the height of the tree (whichever is less).
  2. Pruning cuts shall be made no closer than ½ inch and no farther than 2 inches from the bole of leave trees.
  3. Pruning will be done by first making a cut on the underside of the branch and then severing the branch from above to reduce injury to the branch collar.
- J. See Appendix G for general resource management and flagging requirements.
- K. See harvest cards for specific unit resource management requirements.
2. Hand Pile: Hand piles should be created in units where existing fuel loads are more than desired tons per acre where machines cannot operate, or steep slopes pose a safety issue.
- A. Slash to be piled generally constitutes material from 1-inch DBH up to and including 12 inches DBH.
  - B. Material between 12-20 inches DBH will not be piled. Roll all material of this size at least 10 feet from piles.
  - C. All activity slash created by thinning operation exceeding 1 foot in length will be piled and all material will be cut into sections no longer than 4 feet in length.
  - D. Piles shall be placed on the most dominant cut tanoak stump to assist in the suppression of tanoak sprouts. If no tanoak stump exists within 15' of cutting, piles should be located outside the dripline of overstory trees where possible. If it is not possible then the size of the pile can be reduced to prevent damage to residual stand (i.e. Scorching) but shall not decrease to less than 4 feet in diameter and 4 feet tall.
  - E. Sections of logs may be bucked into sections no longer than 4 feet and piled where necessary to attain 10 foot spacing.
  - F. Piles shall be constructed by hand to facilitate full consumption when they are burned.
  - G. All piles shall be built and compacted by laying limbs, stems, cut



- boles, and other slash so there are minimal air spaces.
- H. Each pile shall include an area of kindling for prompt ignition and to aid in combustion of larger slash. These fuels shall be placed in the center or bottom of the pile. The piles will be constructed so that they will burn after a snow event or rainstorm.
  - I. The minimum pile size will be 4 feet in diameter, but not to exceed 10 feet in diameter. The pile diameter will be symmetrical to each side, in a circle shape.
  - J. All piles will be covered with a minimum 6-millimeter (thickness) plastic sheeting and firmly anchored by either piling slash or other debris in the upper 2/3 of the pile. The plastic shall cover a minimum of 80% of the pile surface area. Covering with plastic will be done at the time of piling.
  - K. The minimum distance between piles will be one and a half times the pile height.
  - L. All material will be contained within the general contour of the pile and any material protruding out 2 feet or more will be sawed off and placed back on the pile.
  - M. Piles shall be located so that burning will not damage standing live trees or physical improvements such as fences, poles, buildings, signs, tables, grills or cattle-guards.
  - N. Piles may be placed along forest service roads. Piles along roadside shall not impede the use of the road by large vehicles such as logging trucks or have risk of rolling into roadways.
  - O. No piles will be placed within:
    - 1. 10 feet from edge of stream channels
    - 2. 15 feet of private property boundaries.
    - 3. 15 feet of unit boundaries.
    - 4. 25 feet of improvements such as, but not limited to, fences, gates, signs or water lines or tanks.
    - 5. 25 feet of any power lines or phone lines
    - 6. 15 feet of standing snags
    - 7. 15 feet of Pacific yew > 4" DBH
    - 8. No piles will be placed on decaying stumps or stobs.

### **Item 3: Wood Processing and Transportation**

The hauling facilities will be determined prior to contract execution and hauling facilities may change throughout the lifetime of this contract.

#### **a. Saw Timber**

- 1. Minimum saw log specifications
  - i. Live and dead trees shall be transported from Project Area to landings. Minimum tree DBH is 10.0 inches with a minimum piece length of 10.5 feet. Minimum top diameter inside bark (d.i.b.) of 6 inches on the short axis.
  - ii. Existing downed trees are to be transported to identified landings following the above specifications.
  - iii. Saw timber trees will be bucked into commercial lengths when feasible. FSH 2409.11 (Forest Service Scaling Handbook).
- 2. Additional volume may be modified into the contract to meet the needs of project

scope.

3. Saw timber shall be decked separately from non-saw timber and biomass piles.
4. Saw timber shall be transported to location(s) identified by the National Forest Foundation.
5. Contractor shall abide by processing requirements and provisions listed in NFF and end use facility agreements. Including, but not limited to: chip size, ash content, total alkali, heating value, and excluded material.
6. Contractor is responsible for coordinating with end use facility to determine delivery schedule to minimize wait time for the trucks and to help facilitate a smooth operation of end us facility.

b. Non-Saw Timber

1. Non-saw specifications
  - i. Live and dead trees shall be transported from Project Area to landings.
  - ii. Trees shall be limbed to a top diameter of 6 inches DBH and lopped. Tops, limbs, and slash developed by Contractor's operations shall be chipped, broadcast, and/or removed to landings or as agreed upon.
  - iii. Logs transported and decked at landings shall be no more than 41 feet long. Deck height shall be no more than 20 feet tall.
2. Additional volume may be modified into the contract to meet the needs of project scope.
3. Non-saw timber shall be decked separately from saw timber and biomass piles.
4. Non-Saw timber shall be transported to location(s) determined by the National Forest Foundation.

c. Biomass

1. Slash, tops, waste, and small diameter trees (<10 inches DBH) will be processed as biomass.
2. Additional volume may be modified into the contract to meet the needs of project scope.
3. Processing may include but is not limited to: chips, pellets, round wood, shavings, biomass, topwood, poles and pilings.
4. Biomass shall be piled separately from saw timber and non-saw timber.
5. Biomass will be transported to location(s) determined by the National Forest Foundation. The contractor will be responsible for contacting the receiving facility to determine the delivery requirements and schedule.

## Item 4: Temporary Road Construction

The Contractor will construct temporary roads identified on harvest cards and the Sale Area Map to specifications described in Appendix F and Appendix G. Temporary road surface width shall be limited to truck bunk width plus four feet, except for needed turnouts which shall not exceed two times the bunk width plus four feet. If shovels or cranes with revolving carriage are used to skid or load, temporary road surface width equal to track width plus tail swing shall be permitted. The Contractor shall employ such measures as outsloping, drainage dips, and water-spreading ditches as necessary to attain stabilization of roadbed and fill slopes of temporary roads.

Should additional miles of temporary road be needed to efficiently and effectively complete commercial thinning, the Contractor shall coordinate with NFF and the Forest Service to determine the location of the new temporary road. The new temporary road will need to be reviewed by the Forest Service resource specialists prior to the construction of the road.

The closeout of temporary roads following the completion of operations will be required. All new temporary roads will be decommissioned as designated by Forest Service personnel, see Management Requirement Soils-2 in Table 8 for details. Decommissioning may include recontouring, subsoiling, or blocking. The Contractor shall notify NFF and the Forest Service, remove bridges and culverts, eliminate ditches, outslope roadbed, remove ruts and berms, effectively block the road to normal vehicular traffic where feasible under existing terrain conditions, and build cross ditches and water bars, as staked or otherwise agreed to. When bridges and culverts are removed, associated fills shall also be removed to the extent necessary to permit normal maximum flow of water.

## **Item 5: Water Draft Site Construction and/or Water Purchasing**

The Contractor shall construct water drafting sites to be used as needed for road maintenance. If choosing to construct water drafting sites, the Contractor shall provide locations and specifications of water drafting sites prior to construction for NFF and Forest Service review and approval. Proposed water drafting sites will need the approval of Forest Service Wildlife and Hydrology Specialists. Alternatively, water may be purchased.

## **Item 6: Road Reconstruction**

The Contractor is authorized to construct roads, bridges, and other transportation facilities, as needed for conducting treatments on National Forest lands. As used in this agreement, “construct” includes “reconstruct”. Reconstruction plans consist of, but are not limited to, barricade installation, dip construction, culvert installation/repair, water bar construction, waterhole development and roadside tree clearing. Specified road reconstruction requirements are in Appendix F (Section F-10a/b) and the Sleighville Road Package in Appendix J.1. Securing County Road encroachment permits is the responsibility of the awarded contractor.

## **Resource Restrictions**

### **Hydrology**

1. Ephemeral (not flagged): Hand work can occur within ephemeral riparian buffers (25' on each side of channel edge).
2. Intermittent (flagged): No vegetation removal, fuels treatment, or ground-disturbing activities will occur within intermittent riparian buffers (50' on each side of channel edge).
3. Perennial (flagged): No vegetation removal, fuels treatment, or ground-disturbing activities will occur within perennial riparian buffers (100' on each side of channel edge).

Mechanical equipment will be allowed to enter riparian conservation areas (RCAs) to retrieve tree bundles but will be limited to one to two passes over the same piece of ground.

1. Ephemeral (not flagged): Mechanical work will not occur in ephemeral buffers (25' on each side of channel edge). Ephemeral RCA is 150' on each side of channel edge.
2. Intermittent (flagged): No vegetation removal, fuels treatment, or ground-disturbing activities will occur within riparian buffers (50' on each side of channel edge). Intermittent RCA is 150' on each side of channel edge.
3. Perennial (flagged): No vegetation removal, fuels treatment, or ground-disturbing activities will occur within riparian buffers (100' on each side of channel edge). Perennial RCA is 300' on each side of channel edge.

### **Wildlife**

Units: 149, 191, 272, 430

Northern Goshawk Limited Operation Period (LOP) from February 15th to September 15th will

be maintained annually prohibiting underburning and mechanical activities that generate noise above ambient levels, such as thinning, piling, tree falling and road maintenance, within approximately 0.25 mile of an activity center, unless surveys confirm that northern goshawks are not nesting or have relocated.

Units: 30, 96, 138, 146, 151, 184, 204, 232, 234, 239, 245, 247, 259, 265, 278, 316, 322, 435, 436, 447, 777

California Spotted Owl LOP from March 1<sup>st</sup> to August 15<sup>th</sup> shall be maintained annually prohibiting mechanical activities that generate noise above ambient levels, such as thinning, piling, tree falling and road maintenance, within approximately 0.25 mile of an activity center, unless surveys confirm that California spotted owls are not nesting or have relocated.

#### Draft Sites

For the protection of aquatic species, at any water drafting site, the use of a FGM 5161, or other similar foot valve with openings less than 2mm will be required. Additionally, the foot valve shall be placed in the deepest section of the water source on a shovel or a plastic/canvas bucket, after the site has been inspected for red- legged frogs or their eggs.

#### Soils

Operate mechanical equipment when soil moisture conditions are such that compaction, gullyng, and/or rutting will be minimal. Outside Normal Operating Season (NOS) or during wet periods within the NOS, utilize the Tahoe Wet Weather Operations Guidelines.

#### Noxious Weeds

Equipment cleaning. All equipment and vehicles operating off-road must be free of invasive plant material before moving into the project area. Equipment will be considered clean when visual inspection does not reveal soil, seeds, plant material or other such debris. Cleaning shall occur at a vehicle washing station or steam-cleaning facility before the equipment and vehicles enter the project area.

## Protection Measures and Other Concerns

**Contractor Responsibility:** The Contractor shall provide everything--including, but not limited to, all equipment, supplies, transportation, labor, and supervision--necessary to complete the project, except for that which the contract clearly states is to be furnished by NFF.

**Contractor-Furnished Equipment:** Equipment shall be furnished on a fully operational basis, of modern design, and in good operating condition, with a competent, fully qualified operator. The Contractor shall furnish all fuel, lubricants, and personnel necessary for the operation of the equipment. All repairs, service and replacements are the responsibility of the Contractor and shall be at the Contractor's expense. If, during the contract period, the equipment requires repairs before operations can continue, it shall be the responsibility of the Contractor to complete such repairs. The Contractor shall provide plastic that is at a minimum 6 millimeter thick.

**Public Safety:** The contractor shall provide for public safety when operating equipment within 200 feet of open roadways and designated trails by posting cautionary signs warning of hazardous work ahead. ***Warning signs (at least two, one for each direction) shall be posted on roads. These shall be located 200' from the intersection of the road and unit boundary at each edge of the unit. Signs shall be posted whenever working to alert oncoming traffic of the safety hazards associated with the operation. Any trails in the project area must also be signed. Signs shall include phrases similar to "Caution, tree falling stay back 200***

**feet” and be no less than 3 feet X 3 feet in size. Lettering shall be at least 6 inches in height.**

**Project Boundary Description:** The perimeters of sub-items will be partially flagged with blue flagging and other areas of the sub-items will be identified with a single piece of flagging. In some cases, roads may make up part of the boundary of the unit and therefore these parts of the unit boundary may or may not be marked or flagged. The project maps are intended to show the general shape and location of the work areas. The map is not intended to be accurate as to precise location and dimension. If the map and field boundaries conflict, the field boundaries shall govern. Positions of streams and topographic features, when shown, also may be approximate.

**Protected Sites and Exclusions (non-work areas):** *The following shall be excluded or protected:*

1. **No hand piling** will be permitted within 10 feet of the banks of **stream channels and waterbodies.**
2. **Cultural resource site buffers** within the project area will be flagged with blue and black striped or red and black striped flagging and avoided. Cultural resource sites will be flagged with white and orange polka dot flagging and avoided.
3. **Sensitive plant avoidance areas** will be flagged in advance of treatment with orange and white-striped flagging. These areas will not be treated and are to be completely avoided during all activities, including staging of equipment, materials and crew as well as tree felling activities.
4. **Noxious weed** infestations will be marked with orange flagging with the words “Noxious Weed” in black prior to commencement of work. These areas will not be treated and are to be completely avoided during all activities, including staging of equipment, materials and crew as well as tree felling activities.

**Applicable Management Requirements**

1. **Survey monuments and bearing trees** shall be protected and not damaged in any way.
2. **All specified roads and recreational trails shown on contract maps** shall be left in the original condition existing prior to the commencement of work on this contract. Any water bars in skid trails disturbed by the Contractor's operations shall be restored to the condition prior to damage at the Contractor's expense. Excessive slash and chips cannot be left in the roadways and recreational trails after the end of each workday. **All cut vegetation shall be kept within unit boundaries. If slash is fell onto the roadways, it must be removed by the end of each workday.**
3. Servicing and refueling equipment areas shall be located at a minimum of 300 feet from streams and other wet areas. In case of a HAZMAT spill, the material shall be immediately contained and NFF shall be immediately notified.
4. Within the sub-item boundaries, NFF may exclude non-work areas such as: rocky areas, wildlife areas, and other special areas. The Contracting Officer's Representative will designate non-work areas. Such areas exceeding 1/2 acre in size per unit may be excluded from payment.

Table 8: Trapper EA Management Requirements

Trapper EA Management Requirements	
Cultural Resources	
Cultural 1	All historic properties within treatment areas will be flagged prior to project implementation.

Cultural 2	All vegetation and tree removal within historic property boundaries using mechanical equipment will be approved in writing by the Forest Heritage Program Manager (HPM) in coordination with the district cultural resource specialist, sale administrators, timber harvest inspectors, burn bosses, and other specialists prior to project implementation.
Cultural 3	<p>Timber removal within historic property boundaries will be subject to the following conditions:</p> <ol style="list-style-type: none"> <li>a. Trees will be topped or limbed to prevent soil gouging during felling.</li> <li>b. Trees will be directionally felled (i.e., dropped away from historic properties). Felled trees will be removed using hand bucking, including the use of chain saws, hand carrying, rubber tired loading, crane/self-loading, helicopter yarding, or other non-ground disturbing methods approved in writing by the HPM or district cultural resource specialist.</li> <li>c. If opportunities to use heavy equipment are available to remove trees or vegetation within historic property boundaries while still avoiding features and artifact concentrations, equipment operators will be briefed on the need to reduce ground disturbance (e.g., minimize turns).</li> </ol>
Cultural 4	<p>Fuel treatments within historic property boundaries will be subject to the following conditions:</p> <ol style="list-style-type: none"> <li>a. Fire lines or breaks will be constructed outside historic property boundaries.</li> <li>b. Fire shelter fabric, fire retardant foam, other wetting agents, or other protective materials or equipment (e.g., sprinkler systems) may be used to protect historic properties.</li> <li>c. Surface fuels (e.g., stumps or partially burned logs) located on historic properties may be covered with dirt, fire shelter fabric, fire retardant foam, other wetting agents, or other protective materials to prevent fire from burning into subsurface components and to reduce the duration of heating.</li> <li>d. Trees that may impact historic properties will be directionally felled prior to ignition or prevented from burning by wrapping in fire shelter fabric or treating with fire retardant foam or other wetting agents.</li> <li>e. Vegetation to be burned will not be piled within historic property boundaries unless locations are identified that avoid features and artifacts concentrations, and locations have been approved in writing by the HPM or district cultural resource specialist.</li> <li>f. Mechanically treated crushed/cut brush or downed woody material will be removed from historic property boundaries by hand, through the use of off-site equipment/long reach equipment, by rubber tired equipment, or by tracked equipment approved in writing by the HPM or district cultural resource specialist. Vegetative or other protective padding may be used in conjunction with HPM or district cultural resource specialist authorization. Ground disturbance will be minimized to the extent practicable during such removals.</li> <li>g. Woody material may be chipped within historic property boundaries if equipment staging areas are approved in writing by the HPM or district cultural resource specialist.</li> </ol>
Cultural 5	An archaeological monitor will be onsite during all work within or directly adjacent to historic property boundaries.

Cultural 6	Following project activities, access to historic properties will be blocked or disguised where feasible.
Cultural 7	Hazard tree removal within or adjacent to historic property boundaries will be approved in writing by the HPM or district cultural resource specialist.
Cultural 8	If previously unrecorded historic properties are encountered during project implementation, all work in the vicinity will immediately cease and the HPM and district cultural resource specialist will be notified immediately. Work may resume after written approval by the HPM or district cultural resource specialist if no effects or no adverse effects to historic properties will occur.
<b>Soils</b>	
Soils 1	<p>Ground-based mechanical equipment is restricted to slopes less than 30% with the identified exceptions:</p> <ul style="list-style-type: none"> <li>a) On slopes up to 35%, low pressure (ie high floatation and/or dual tire) equipment can be used, tracked equipment can be used on slopes up to 40%, and tethered equipment is required beyond this threshold.</li> <li>b) Rutting during operations will not exceed a depth of 6 inches.</li> <li>c) Non-tethered uphill or adverse skidding is restricted to 25% slope in RCAs and 30% elsewhere.</li> <li>d) Additional precautions or repairs may be required if excessive disturbance occurs.</li> <li>e) The Forest Service may approve steeper pitches limited to less than 100 feet.</li> </ul>
Soils 2	All new temporary roads and up to 0.5 acre of skid trail per landing will be decompacted as designated by Forest Service personnel. Decompaction will be accomplished with equipment such as a winged sub-soiler or other tilling device, to a maximum depth of approximately 24 inches so that the soil is lifted vertically and fractured laterally to alleviate detrimental compaction (where it occurs). Decompaction depth may be reduced based on level of soil compaction and soil consistency in coordination with the Forest Service soil scientist or hydrologist. Decompaction will be completed at least 8 feet from the trunk of larger trees so root systems are not impacted. On decompacted temporary roads and skid trails, soil cover will be added to achieve at least 70 percent effective soil cover prior to winter precipitation. Soil cover may consist of mulch, clearing or logging slash, stumps or other woody debris. Soil cover will be placed and scattered uniformly on the top of the skid trail or road corridor to discourage unauthorized use. On temporary roads, road prisms and cut/fill slopes will be recontoured to natural conditions and contours.
Soils 3	Mechanical equipment will only be operated when soil moisture is less than 20 percent by weight. Forest Service standard contract provision Erosion Prevention and Control will be used to suspend operations due to wet weather, high water, and other adverse operating conditions. If a Forest Service soil scientist or hydrologist is unavailable to sample soil, contract administrators will use the ball method to test for operability. This protocol includes digging a small pit and sampling 4 to 6 inches below the mineral soil surface (i.e., below the surface litter), collecting enough soil to form a 1-to 2-inch ball with hand pressure, picking out excessive rock fragments, and squeezing the ball with 6 directional squeezes. If the ball that is formed holds together under repeated tosses 1 to 2 feet into the air, then the soil will be too wet for equipment operation.

Soils 4	<p>To accomplish machine piling, excavator type equipment with a rotating arm will be used to grab slash from above. Machine piling with bulldozers will be avoided unless the following Tahoe National Forest Tractor Piling Guidelines are met.</p> <ol style="list-style-type: none"> <li>a. A pre- and post-activity monitoring plan is developed.</li> <li>b. Slope limitations of less than 30 percent are in place, with slope limitations of 30 to 40 percent considered with site specific analysis by a natural resource specialist.</li> <li>c. A natural resource specialist reviews contractual requirements prior to advertisement and participates in the pre-op meeting (in contract actions).</li> <li>d. A natural resource specialist reviews project specifications and tractor operator instructions prior to operations (in Force Account Actions).</li> <li>e. Erosion control measures are included in the contract for tractor piling.</li> <li>f. Soils are dry to a depth of approximately 8 inches.</li> <li>g. Uprooting of shrubs is minimized.</li> <li>h. The “brush rake” is kept out of the ground to retain litter and duff.</li> <li>i. No soil or minimal soil is placed in piles.</li> </ol>
Soils 7	<p>Except for roadside fuel breaks and defense zones, at least three tons of large wood greater than three inches in diameter will be maintained during hand or machine piling.</p>
Soils 8	<p>Best management practices (BMPs) 4.7.1 to 4.7.8 will be followed.</p> <ol style="list-style-type: none"> <li>a. BMP 4.7.1 requires planning trail locations to avoid, minimize, and mitigate adverse impacts to aquatic and riparian resources.</li> <li>b. BMP 4.7.2 requires locating off highway vehicle (OHV) trails in areas that minimize hydrologic connectivity and requires incorporation of drainage structures into their design to disperse concentrated runoff.</li> <li>c. BMP 4.7.3 requires preventing or minimizing the discharge of sediment into water bodies when locating, designing, constructing, reconstructing, and maintaining watercourse crossings.</li> <li>d. BMP 4.7.4 requires preventing or minimizing the discharge of sediment into water bodies during construction, reconstruction, and realignment of OHV trails.</li> <li>e. BMP 4.7.5 requires trail monitoring once at least every three years. It also requires temporarily closing trails that pose immediate significant threats to water quality.</li> <li>f. BMP 4.7.6 requires closing newly constructed trails for one season.</li> <li>g. BMP 4.7.8 requires restoring OHV damaged areas, watercourse crossings, and OHV trails no longer designated for use to prevent or minimize the discharge of sediment into watercourses and water bodies.</li> </ol>
Soils 9	<p>Identified roads will be decommissioned by effectively closing to all vehicle traffic. Decompaction of soils on decommissioned roads will be conducted as described in Soils 2. Erosion will be controlled by installing waterbars and maintaining at least 70 percent effective soil cover prior to winter precipitation. Culverts and berms will be removed, waterbars will be installed, and surfaces will be outsloped. Where possible, vegetated areas will be left undisturbed. These treatments will follow the requirements of BMP 2.7 which requires stabilizing, restoring, and vegetating unneeded roads to a more natural state so they do not represent a significant impact to water quality.</p>
Hydrology	



Hydrology 1	<p>Riparian Conservation Areas (RCAs) will be established for all stream courses. Riparian Conservation Objectives (RCOs) will be met within RCAs by adhering to RCA Guidelines established in BMP 1.8 Streamside Management Zone Designation. These guidelines specify the types of activities that can be conducted within RCAs. No harvest or mechanical equipment will be allowed in riparian buffers unless agreed to by a natural resource specialist. RCA and riparian buffer widths are as follows:</p> <table border="1" data-bbox="391 478 1344 1115"> <thead> <tr> <th data-bbox="391 478 711 548">Stream Type</th> <th data-bbox="711 478 1031 548">Riparian Conservation Area</th> <th data-bbox="1031 478 1344 548">Riparian Buffer</th> </tr> </thead> <tbody> <tr> <td data-bbox="391 548 711 653">Perennial stream</td> <td data-bbox="711 548 1031 653">300 feet each side of stream measured from channel edge.</td> <td data-bbox="1031 548 1344 653">100 feet on each side of stream measured from channel edge.</td> </tr> <tr> <td data-bbox="391 653 711 758">Intermittent stream</td> <td data-bbox="711 653 1031 758">150 feet each side of stream measured from channel edge.</td> <td data-bbox="1031 653 1344 758">50 feet on each side of stream measured from channel edge.</td> </tr> <tr> <td data-bbox="391 758 711 863">Ephemeral stream</td> <td data-bbox="711 758 1031 863">150 feet each side of stream measured from channel edge.</td> <td data-bbox="1031 758 1344 863">25 feet on each side of stream measured from channel edge.</td> </tr> <tr> <td data-bbox="391 863 711 968">Stream in inner gorge</td> <td data-bbox="711 863 1031 968">Top of inner gorge</td> <td data-bbox="1031 863 1344 968">25 feet on each side of stream measured from channel edge.</td> </tr> <tr> <td data-bbox="391 968 711 1115">Meadows, lake, and spring</td> <td data-bbox="711 968 1031 1115">300 feet from edge of feature or riparian vegetation whichever is greater.</td> <td data-bbox="1031 968 1344 1115">100 feet on each side of feature measured from channel edge.</td> </tr> </tbody> </table>	Stream Type	Riparian Conservation Area	Riparian Buffer	Perennial stream	300 feet each side of stream measured from channel edge.	100 feet on each side of stream measured from channel edge.	Intermittent stream	150 feet each side of stream measured from channel edge.	50 feet on each side of stream measured from channel edge.	Ephemeral stream	150 feet each side of stream measured from channel edge.	25 feet on each side of stream measured from channel edge.	Stream in inner gorge	Top of inner gorge	25 feet on each side of stream measured from channel edge.	Meadows, lake, and spring	300 feet from edge of feature or riparian vegetation whichever is greater.	100 feet on each side of feature measured from channel edge.
Stream Type	Riparian Conservation Area	Riparian Buffer																	
Perennial stream	300 feet each side of stream measured from channel edge.	100 feet on each side of stream measured from channel edge.																	
Intermittent stream	150 feet each side of stream measured from channel edge.	50 feet on each side of stream measured from channel edge.																	
Ephemeral stream	150 feet each side of stream measured from channel edge.	25 feet on each side of stream measured from channel edge.																	
Stream in inner gorge	Top of inner gorge	25 feet on each side of stream measured from channel edge.																	
Meadows, lake, and spring	300 feet from edge of feature or riparian vegetation whichever is greater.	100 feet on each side of feature measured from channel edge.																	
Hydrology 2	Recruitment of downed logs will occur and disturbance within riparian areas will be minimized by falling and leaving hazard trees within the perennial and intermittent riparian buffer unless otherwise agreed to by a natural resource specialist (BMP 1.8).																		
Hydrology 3	No vegetation removal, fuels treatment, or ground-disturbing activities will occur within riparian buffers unless otherwise agreed to by a natural resource specialist. Mechanical equipment will be allowed to enter RCAs to retrieve tree bundles but will be limited to one to two passes over the same piece of ground. This will be documented on harvest cards. No new landings or roads will be located within RCAs.																		
Hydrology 5	Fuels and other toxic materials will be stored outside of RCAs (Standard and Guide No. 99, BMP 2.10 Parking and Staging Area and BMP 2.11 Equipment Refueling and Servicing).																		
Hydrology 6	Construction of trail stream crossings will be located in the shallow portions of the stream (e.g., low water crossing). Crossings where streams turn will be avoided as water could undercut approaches on the outside of a turn. Approaches will be constructed a short distance above the typical high water line so water isn't channeled down the trail. The portion of the trail in the crossing will be level and ideally made of rock or medium sized gravel that provides solid footing. Waterflow within the crossing will remain even so the gravel-sized material isn't washed away, leaving only cobble or boulders.																		

Hydrology 7	Where possible, crossing approaches will be made short and level, or reverse grade. Cross drainage will be installed at crossings to prevent water and sediment from being channeled directly into watercourses. Drainage features will be located as close to the crossing as possible without being hydrologically connected to the watercourse. Steep crossing approaches will be armored with stable aggregate or trail-hardening materials.
Hydrology 8	Trail grade will be less than half of the sideslope grade. For example, on a hill with 6 percent sideslope, trail grade will be no more than 3 percent. Small draws will be used to locate trail grade reversals. Trails will climb gently for a few feet on each side of the draw.
<b>Silviculture</b>	
Silviculture 1	Burn piles will be placed away from the base of residual trees.
Silviculture 2	Burn piles will be placed approximately 50 feet away from property lines. Residual fuels and piles will be placed approximately 100 feet away from homes and roads to homes. Piles may be placed closer with approval from the District Fuels Specialist.
Silviculture 3	Where feasible, chipping will occur away from large legacy trees and oaks that are greater than 30-inches DBH.
Silviculture 5	Hardwoods (except tanoak) greater than 4 inches DBH will not be removed except to allow for equipment operability or safety. Individual trees and pockets of smaller hardwoods may be flagged for avoidance during operations. Pockets of regenerated black oak from stump sprouts may be released (i.e., thinned) using silvicultural prescriptions.
Silviculture 6	Within treatment areas, snags will be retained consistent with Tahoe National Forest Land and Resource Management Plan standards. Generally, the four largest snags will be retained per acre, averaged over the entire implementation area. Snags will not be evenly spaced across the landscape, but will vary based on land allocation, such as WUI, and landscape positions, such as near roads, ridgetops and streams.
Silviculture 7	Small (e.g., 4 to 10 inches DBH) conifer trees and un-utilizable conifers (e.g., 10 to 16 inches DBH) that are marked or designated by description in silvicultural prescriptions will be removed and moved to landings concurrent with commercial harvest.
Silviculture 8	Landing size will be limited to the smallest size necessary to accommodate logging operations and slash pile storage. Biomass accumulated on landings could be disposed of in a number of ways, including on-site burning, commercial and personal firewood, or as co-generation fuel if plausible. Trees killed during burning of landing piles will be retained as additional snags unless they pose a hazard
Silviculture 9	During thinning and prescribed burning, rust resistant sugar pine trees identified on the sale area map will be protected.
Silviculture 10	Roadside hazard trees of Medium or High rating may be removed within thinning units in accordance with Forest Health Protection (Report # RO-12-01) and Hazard Tree Guidelines for Forest Service Facilities and Roads in the Pacific Southwest Region (USDA Forest Service, 2012). Hazard trees greater than 30 inches DBH will be reviewed for consistency with hazard tree guidelines by natural resource staff.

Silviculture 11	<p>Treatments of hardwood will be designed to avoid or minimize vigorous resprouting that could result from the cutting of mature tanoak and madrone.</p> <ol style="list-style-type: none"> <li>a. Cutting of tanoak and madrone will be limited to the minimum extent needed to meet fuels and timber objectives and operability.</li> <li>b. Larger hardwood trees and single stem hardwoods will be maintained with enough cover to preclude dense resprouting after treatment.</li> <li>c. In areas where resprouting of hardwoods does occur or where multiple- stemmed tanoak are present, treatments, such as selective mechanical removal will be designed to culture tanoak after it is approximately ten years old when dominant stems are more successful at suppressing resprouting.</li> </ol>
<b>Biological Resources</b>	
Wildlife 1 – Limited Operating Periods (LOPs) for Wildlife	<p>Limited Operating Periods (LOPs) for Wildlife</p> <ol style="list-style-type: none"> <li>a. In California spotted owl PACs, an LOP from March 1st to August 15th will be maintained annually prohibiting underburning and mechanical activities that generate noise above ambient levels, such as thinning, piling, tree falling and road maintenance, within approximately 0.25 mile of an activity center, unless surveys confirm that California spotted owls are not nesting.</li> <li>b. In northern goshawk PACs, an LOP from February 15th to September 15th will be maintained annually prohibiting underburning and mechanical activities that generate noise above ambient levels, such as thinning, piling, tree falling and road maintenance, within approximately 0.25 mile of a nest, unless surveys confirm that northern goshawks are not nesting. If surveys do not locate the nest stand within the PAC, the LOP will be applied to a 0.25 mile area surrounding the PAC.</li> <li>c. Prior to the onset of work in all PACs, coordination with the District Biologist will occur to establish whether the affected PAC is in nesting status.</li> </ol>
Wildlife 4 - Snags	<p>Hazardous trees or snags greater than 24 inches DBH will be felled and left in order to recruit large down woody debris up to levels identified as the desired condition for the area. Fallen trees/snags will not be bucked up into small pieces but will be retained as whole logs or large pieces, where feasible.</p>
Wildlife 5 – Large Down Woody Debris	<p>Large Down Woody Debris If trees identified as cull must be cut for safety reasons, they will be left onsite as large woody debris, not to exceed desired fuel levels.</p>
Wildlife 6 - Cover	<p>Piling within the drip line of large conifer and hardwood trees, snags, and large downed logs will be avoided.</p>

Aquatics 1	<p>Prior to the onset of work, environmental awareness training for sensitive species and habitats will be given by an aquatic/wildlife biologist or trained staff to all project personnel (i.e., Forest Service and contractor). If new personnel are added, they will receive the mandatory training before starting work. Training will include:</p> <ol style="list-style-type: none"> <li>a. Description and illustration of California red-legged frog, Sierra Nevada yellow-legged frog, and foothill yellow-legged frog.</li> <li>b. Aquatic and terrestrial habitat requirements for each species.</li> <li>c. What to do if a frog is encountered.</li> </ol>
Aquatics 2	<p>A LOP for California red-legged frog will be implemented as described below.</p> <ol style="list-style-type: none"> <li>a. During the wet season (defined as starting with the first frontal rain system that deposits a minimum of 0.25 inches of rain on or after October 15th and ending April 15th), no ground disturbance or prescribed burning (underburning and pile burning) will occur within 300 feet of suitable breeding habitat for California redlegged frog for 72 hours following a rain event.</li> <li>b. Coordination with the District Aquatic/Wildlife Biologist will occur prior to the onset of work near potential breeding habitat to determine if the above LOP is necessary for that site. The LOP may be lifted if the District Aquatic/Wildlife Biologist determines that the water body does not meet the definition of suitable California red-legged frog breeding habitat, as described in the USFWS species profile.</li> </ol>
Aquatics 3	<p>Broadcast application of herbicides will not occur within 50 feet of riparian vegetation or surface water, unless approved by the District Aquatic/Wildlife Biologist.</p>
Aquatics 4	<p>Herbicide mixing will not occur within 150 feet of surface waters, except at existing facilities. No mixing will occur within 500 feet of known sites occupied by foothill yellow-legged frog. The maximum amount of herbicides temporarily stored near waterbodies during application will be limited to 10 gallons.</p>
Aquatics 5	<p>No piling or pile burning will occur within the riparian buffer (RCAs), unless approved by the District Aquatic/Wildlife Biologist. Riparian vegetation will not be cut where piling is allowed.</p>
Aquatic 6	<p>Burn piles will be placed a minimum of 150 feet away from ephemeral streams and a minimum of 300 feet away from perennial and intermittent streams, unless approved by the District Aquatic/Wildlife Biologist. Piles will be located outside areas that may receive runoff from roads. Directional hand pile lighting will be conducted, so that all hand piles are ignited on only one side of the pile, not to exceed half the circumference of the pile, on the side furthest from the nearest aquatic feature.</p>
Aquatics 7	<p>Drafting site locations will be coordinated with the District Aquatic/Wildlife Biologist prior to use.</p>
Aquatics 8	<p>Drafting devices will use a 2 millimeter or less screen and the hose intake will be placed into a bucket in the deepest part of the pool. A low velocity water pump will be used and ponds will not be pumped to levels beyond which they cannot recover quickly (e.g., approximately one hour).</p>

Aquatics 9	All water drafting vehicles will be checked daily and will be repaired as necessary to prevent leaks of petroleum products from entering RCAs or water. Operators of water drafting vehicles will have access to petroleum spill kits and training in effective spill kit deployment. Absorbent pads will be disposed of in accordance with a Hazardous Response Plan which will be developed by the contractor and approved by the Forest Service.
Aquatics 10	Any petroleum spill into water will be immediately contained and reported to NFF and Forest Service dispatch.
Threatened/Endangered Species 1	If federally threatened or endangered species are detected within 300 feet of the implementation area prior to or during project activities, any activities in the sighting area that could result in adverse effects to the species will stop or not commence, and the District Aquatic/Wildlife Biologist will be notified immediately. The District Aquatic/Wildlife Biologist will contact the USFWS for additional guidance before work can resume in the area where the species was encountered. An appropriate LOP or other protective action such as modification of the RCA will be applied, as needed. Federally-listed species will not be handled or harassed during any activity related to the proposed action, and species will be allowed to leave the active work area on their own accord.
<b>Botanical Resources</b>	
Botanical Resources 1 – Cantelow's lewisia	<p>There are known occurrences of Cantelow's lewisia in Units 171, 238, 252, FB7, U07, U08, and U11.</p> <ul style="list-style-type: none"> <li>a. Cantelow's lewisia occurrences will be buffered by 100 feet and avoided during all activities, including herbicide application.</li> <li>b. Avoidance areas will be flagged in the field, identified on project maps and provided to contractors.</li> <li>c. Underburning within and adjacent to occurrences will be allowed.</li> </ul>
Botanical Resources 2 – Forest Service Watch List Occurrences	<p>There are known occurrences of Humboldt lily in Units 7, 56, 64, 66, 232, 298, 331, 356, 414, and F11.</p> <ul style="list-style-type: none"> <li>a. No herbicide application will occur within 50 feet of occurrences.</li> <li>b. No fuel and slash piling, log decking, staging of equipment and personnel, ground disturbance and off-road vehicle use will be allowed within 50 feet of occurrences.</li> <li>c. Trees will be felled away from occurrences.</li> <li>d. Underburning and hand cutting will be allowed within occurrences.</li> <li>e. Avoidance areas will be flagged in the field, identified on project maps, and provided to contractors.</li> <li>f. Modifications may be made in consultation with the natural resource specialist.</li> </ul>
Botanical Resources 3 – Serpentine Barrens	No ground disturbance, including fireline construction and pile burning, will occur in serpentine barrens.
Botanical Resources 4 – Undetected Botanical Resources	If unanticipated threatened and endangered plant species, watch list plant species or other FS botanical resources are discovered prior to or during project implementation, species will be flagged and avoided completely until they can be assessed by the natural resource specialist.
<b>Invasive Plant</b>	

Invasive Plant 1 – Avoidance Areas	<p>Avoidance Areas</p> <ol style="list-style-type: none"> <li>Invasive plant infestations that have not been treated prior to implementation will be avoided.</li> <li>Avoidance areas will be flagged in the field, identified on project maps, and provided to contractors.</li> <li>Coordination with the natural resource specialist will occur at least 60 days before implementation of planned treatments.</li> </ol>
Invasive Plant 2	Fuels treatments within broom infestations will be limited to hand cutting and pile burning. Hand cutting of brooms will be timed to late summer to minimize resprout potential.
Invasive Plant 3 – Equipment Cleaning	All equipment and vehicles (i.e., Forest Service and contractor) operating off-road will be free of invasive plant material before moving into the project area. Equipment will be considered clean when visual inspection does not reveal soil, seeds, plant material or other such debris. Cleaning will occur at a vehicle washing station or steam-cleaning facility before equipment or vehicles enter treatment areas.
Invasive Plant 4 – Equipment Cleaning (Infested Project Areas)	All equipment and vehicles (i.e., Forest Service and contractor) operating off-road in invasive plant infestations will be cleaned before moving to other National Forest Service system lands. Invasive plant infestations will be flagged in field and identified on project/contractor maps.
Invasive Plant 5 – Weed-Free Construction Materials	All gravel, aggregate, fill, mulch, topsoil, erosion control materials and other construction materials will be weed-free. When possible, onsite materials will be used unless contaminated with invasive species. Otherwise, materials will be obtained from sources that have been certified as weed-free.
Invasive Plant 6 – Project-Related Disturbance	During construction activities, including landings construction, new ground disturbance will be minimized. Vegetation will be reestablished on disturbed bare ground, particularly landings to reduce invasive species establishment.
Invasive Plant 7 - Revegetation	Seed and plant mixes used for revegetation will be approved by the natural resource specialist. Neither invasive species nor persistent non-natives will be used in revegetation. Seed lots will be tested for weed seed. Seed and plant material will be collected from as close to the project area as possible, preferably from within the same watershed or at a similar elevation.
Invasive Plant 8	<p>Early Detection</p> <p>Any additional infestations discovered prior to or during project implementation will be flagged and avoided. All new infestations will be reported to the natural resource specialist.</p>

**Flagging Identification:**

- Boundary: Blue
- Cultural Sites: Blue & Black Striped or Red & Black Striped buffer; White & Orange Polka Dot at resource site.
- LOP: Black & Orange Striped
- Botany (Sensitive Plants and Noxious Weeds): Orange & White Striped with Black

“Special Treatment” Lettering

- Hydrology: White & Blue striped

**Required Training:** Environmental awareness training will be conducted to contract representatives, Contract Officers, project managers, and field personnel prior to the onset of project work. Training will include a briefing on the following: (a) How to recognize Sierra Nevada yellow-legged frogs, (b) The specific measures that are being implemented to conserve the species, (c) The penalties for non-compliance, (d) If a Sierra Nevada yellow-legged frog is encountered in the work area, work activities in that area shall cease until the species has moved from the area on its own volition, or a U. S. Fish and Wildlife Service-approved biologist moves the individual in accordance with Forest Service approved procedures. If any injured or killed Sierra Nevada yellow-legged frogs are found, work activities will immediately cease in the area, and the COR or approved biologist will be notified as soon as possible to take appropriate action, which includes notification within 24 hours to the U. S. Fish and Wildlife Service.

**Restrictions on Work:** Work may be performed at any time during the period of the contract, except as outlined here. Restrictions are as follows:

1. In accordance with the fire plan, included in Appendix H.
2. When the Contracting Officer (or designated representative) determines that adverse weather has made access too dangerous or that continued vehicular travel would cause unacceptable road damage.
3. When the Contracting Officer (or designated representative) determines that continued operation may be injurious to leave trees.
4. In units with an LOP for California spotted owl, no work shall occur from March 1 – August 15.
5. If any Sierra Nevada yellow-legged frog is found at any time during implementation of this Project, cease operations in the vicinity of the frog, vacate the immediate area and leave the frog along. If possible, take a photograph of the frog as follows: top looking down, and side view. No activity will occur in that area until such time as the frog has vacated the area on its own volition. With the exception of a U. S. Fish and Wildlife Service approved biologist, do not handle Sierra Nevada yellow-legged frogs. Report the occurrence as soon as possible to the COR or Designated Representative.
6. Within 300 feet of perennial and intermittent creeks, and 30 feet of ephemeral creeks, limit the operating period for mechanical treatments during the wet season, which is defined as the first frontal rain system depositing a minimum of 0.25 inches of rain after October 15 and ending April 15. The LOP may be lifted only if an aquatic biologist determines that the stream does not meet the definition of suitable Controlled Area red-legged frog habitat (described in guidelines provided by the US Fish & Wildlife Service, California Red Legged Frog Take Avoidance Scenarios March 25, 2008), or that activities will occur further than 300 feet from suitable habitat.

**Definitions:**

**Aggregation** – A pocket of densely packed trees distinct from adjacent areas within a project unit. It is characteristic for trees within aggregations to have a higher percentage of *phenotypic defects* due to competition for resources in close proximity to others.

**Brush** – all woody shrub species such as manzanita, whitethorn, deerbrush, dwarf tanoak, silktassel and ribes. For the purposes of this contract bear clover, snowberry, prostrate manzanita and squaw carpet are not considered brush.

**Conifer** - A cone-bearing tree with needles or leaf scales (e.g. pine, fir, cedar).

**Co-dominant Tree** - A tree with the crown forming the general level of the crown cover and receiving full light from above, but comparatively little from the sides.

**C.O.R.** - Contracting Officer's Representative.

**Crop Tree (Leave Tree)** - Any crop tree without excessive damage, which has a live crown ratio of greater than 30%. The top will not be dead, broken, or forked.

**Damaged tree** – Any crop tree with one or more of the following injuries:

1. Any true fir that has any bark cut or removed to the cambium regardless of the amount.
2. Any other tree species that has bark cut or removed to the cambium from more than 25% of the circumference of the bole.
3. Any tree that has a broken, forked, or dead top.
4. Any tree that has had 25% or more of the live limbs or branches broken or removed by any operation.
5. Defects, which include sweeps in the bole and crooked boles.

**DBH** - Diameter at breast height; the diameter of a tree measured at a point 4-1/2 feet above the ground on the uphill side of the tree.

**Diseased Trees** – Any tree greater than two feet tall with a diameter less than ten inches at DBH with one or more of the following diseases:

1. **Mistletoe:** Trees with one or more visible infections on any part of the live crown or stem.
2. **Gall Rust:** Trees with one or more visible cankers on the bole or multiple cankers on the limbs in the green crown.
3. **Chlorosis:** Trees with off color foliage, weak root system and otherwise exhibiting a general unhealthy appearance.
4. **Damage:** Tree that exhibits insect infestation, severe mechanical, animal, or other damages (i.e. trees leaning severely).
5. **White Pine Blister Rust:** On sugar pine, stem / branch cankers, yellow to red flagging of branches and tops.

**Dying Tree** – 50% or more of the foliage-bearing crown is recently dead and/or 75% or more of the circumference of the lower bole is girdled by wildlife.

**Excess Tree** - A tree that is left but should have been cut to meet standards.

**Foliage** – Tree/plant leaves.

**Forked Trees** – Trees with one or more forks in the live crown or with old dead or broken-out tops within 13 feet of the ground.

**Girdled** – A cut through the tree bark or branch all the way around.

**Hang-up Tree** – A cut tree suspended above the ground by a leave tree.

**Hardwood** – A tree with broad leaves rather than needles (e.g., oak, madrone, big leaf maple, elderberry, dogwood, etc.)

**Insect Infested Tree** – A tree pitching sap from the bark in multiple spots on the bole, frass in cracks of bark or at base of tree, dead or fading top.

**Limited Operating Period (LOP)** – This indicates there is a limited period in which operations may NOT occur for a particular work unit. This period is variable based on the species being protected. See the Schedule of Treatments for the definition of each LOP.

**Live Crown Ratio** – The percentage of the live limbs in relation to the total tree height.



**Invasive plants (Noxious Weeds)** - For the purpose of this contract, the following list refers to species on the Tahoe National Forest Invasive Plant List, last updated 05/01/2017, namely:

<b>Scientific Name</b>	<b>Common Name</b>
<i>Acroptilon repens</i>	Russian knapweed
<i>Aegilops triuncialis</i>	barbed goatgrass
<i>Ailanthus altissima</i>	tree-of-heaven
<i>Arundo donax</i>	giant reed
<i>Bromus tectorum</i>	cheatgrass
<i>Berteroa incana</i>	hoary alyssum
<i>Carduus nutans</i>	musk thistle
<i>Carduus pyconcephalus</i>	Italian thistle
<i>Centaurea diffusa</i>	diffuse knapweed
<i>Centaurea melitensis</i>	Maltese starthistle
<i>Centaurea solstitialis</i>	yellow starthistle
<i>Centaurea stoebe</i>	spotted knapweed
<i>Chondrilla juncea</i>	skeletonweed
<i>Cirsium arvense</i>	Canada thistle
<i>Cortaderia selloana</i>	pampasgrass
<i>Cytisus scoparius</i>	scotchbroom
<i>Dittrichia graveolens</i>	stinkwort
<i>Elymus caput-medusae</i>	medusahead
<i>Euphorbia oblongata</i>	oblong spurge
<i>Foeniculum vulgare</i>	fennel
<i>Genista monspessulana</i>	French broom
<i>Hydrilla verticillata</i>	hydrilla
<i>Isatis tinctoria</i>	dyer's woad
<i>Lepidium chalepensis</i>	lenspod whitetop
<i>Lepidium draba</i>	whitetop
<i>Lepidium latifolium</i>	tall whitetop

<i>Linaria dalmatica</i> ssp. <i>dalmatica</i>	Dalmatian toadflax
<i>Lythrum salicaria</i>	purple loosestrife
<i>Myriophyllum spicatum</i>	Eurasian water milfoil
<i>Onopordum acanthium</i>	Scotch thistle
<i>Phalaris arundinacea</i>	reed canary grass
<i>Rubus armeniacus</i>	Himalayan blackberry
<i>Spartium junceum</i>	Spanish broom
<i>Ulex europaeus</i>	gorse

**Phenotypic Defects** - Referring to inherited defects or deficiencies caused by local environmental conditions. Examples: Trees with flat top shapes having under 4 inches of leader growth (measure of previous year), forked or multiple tops, twisting in the limbs bole and trees with sweeping, leaning or drooping forms.

**Riparian Conservation Area (RCA)** – Areas adjacent to streams, ponds, and springs protected by limiting treatments in some situations. RCA's are as follows:

- Perennial streams = 300 feet each side of channel
- Seasonal (Intermittent and Ephemeral) = 150 feet each side of channel
- Streams in Inner Gorge = Top of inner gorge
- Special Aquatic Features (meadows, lakes, and springs) = 300 feet from edge of feature or riparian vegetation, whichever is greatest.

**Scour Zone** – The zone where moving water runs-off and removes any surface cover down to bare mineral soil.

**Slash** - All debris resulting from operations including stems, limbs and tops of trees, and brush.

**Suppressed Tree** - Any tree with less than 30% of its total height in live green crown or with less than 4 inches of current leader growth.

**Thinning** - The cutting of trees to meet the short-term desired condition.

**True fir** – This classification refers to the conifer species red fir & white fir.

## Inspection and Acceptance of Service Work Items

Upon the Contractor's request and assurance that work has been completed, the NFF's contracted Registered Professional Forester will conduct inspection and acceptance of service work items following the below inspection procedures. Such a request may be for acceptance of:

- (a) Any reasonable portion of Specified Road listed in the Schedule of Items;
- (b) Specific requirements on a subdivision of Sale Area (such as logging, slash disposal, erosion control, or snag felling); or
- (c) All contract requirements on a subdivision of Sale Area.

After confirming that work has been completed to specification, the Registered Professional Forester will notify and provide documentation to the Forest Service. The Forest Service shall conduct inspections for the acceptance of work identified above. Within 2 days of inspection, excluding

weekends and Federal holidays, Forest Service shall furnish Contractor and NFF with written notice either of acceptance or of work remaining to be done. In the event that Forest Service is unable to make such inspection within 5 days of notification from NFF or the Registered Professional Forester, Contractor shall be notified in writing of necessity for postponement and time when inspection can be made.

The Registered Professional Forester and the Forest Service may perform inspections without request from the Contractor. Inspections by the Forest Service may be performed after all contract items have been completed through close out. If a unit has not been completed through close out (i.e. cut, skid, deck, and hauling is complete, but landings and temp roads haven't been sufficiently closed out) and the Contractor wishes to invoice for the work that has been complete, the Contractor may choose to invoice for service work items of up to 90% of the total cost of all service work items completed for that unit. The final 10% may be invoiced after unit close out and approval of final inspection from the Forest Service.

## **Inspection Procedure**

### **1. Sampling**

*Plots.* At least 0.5 percent of each treatment area will be sampled by a random series of plots distributed over the entire area. Plot size will be:

1/250 acre

1/100 acre

1/50 acre

1/10 acre

other – 20 BAF Variable plot

1/10 acre plot is a circular plot measured on a horizontal plane having a radius of 37.2 feet. 20 BAF variable plots will be completed on commercial thinning item inspections.

### **2. Specific Inspection Procedures**

Work will be accepted for payment on the basis of final inspection and passage of specification. NFF or the Forest Service will inspect for compliance of specifications. Plots will be located throughout the unit so as to obtain a representative sample of the area. Items will be inspected separately and not combined for the purpose of determining percent of satisfactory work.

A series of 1/10-acre plots (37.2 foot plot radius) distributed over the entire unit will be taken. An embedded variable plot (20 BAF) will be used to record residual basal area for designation by prescription commercial thinning items. Plot centers will be marked with a Pin Flag. Plot information will be written on Pin Flag with permanent marker. Plot information will include the name of plot inspector, date, BAF, and plot number.

On each plot the RPF/NFF or the Forest Service will record the plot number, whether the plot is satisfactory or unsatisfactory and the reason if unsatisfactory. Each plot will be examined to record findings on the performance measures listed below. To be considered satisfactory, each item must meet the following criteria:

### **Performance Measures for Commercial Thinning (DxP)**

Each of these gets a rating of 0-5 for a total of 20 points possible, with 0 being unacceptable and 5 being acceptable.

1. Residual basal area between 60-120 per acre.
2. Selection of leave trees (species priority and DBH): Hardwoods>JP/PP > SP >RF> DF > IC > WF>LP. Conifers >30 inches DBH. Tanoak >12 inches DBH.
3. Stump height 3-12 inches on the uphill side.
4. No conifers within 25 feet of dripline of black oak and small oaks in cluster regeneration.

### **Performance Measures for Commercial Thinning (ITM)**

Each of these gets a rating of 0-5 for a total of 15 points possible, with 0 being unacceptable and 5 being acceptable.

1. Stump height is 3-12 inches on the uphill side
2. All cut trees were marked.
3. Unmarked trees are left.

### **Performance Measures for Machine Cutting and Remove to Landing**

Each of these gets a rating of 0-5 for a total of 35 points possible, with 0 being unacceptable and 5 being acceptable.

1. Number of residual trees under 10 inches DBH remaining on a per acre basis (20 trees per acre).
2. Spacing of residual trees under 10 inches DBH remaining (45-50' spacing).
3. Selection of leave trees (species priority and DBH): JP/PP > SP >RF> DF > IC > WF>LP. No hardwoods > 4 inches DBH, big leaf maple, elderberry, dogwood, Pacific yew, and California Hazelnut removed.
4. Health of residual tree (straightest bole, free of damage due to insects, disease, physical and mechanical causes).
5. No snags less than 10 inches DBH present. Snags >24 inches DBH felled and left.
6. Stump height of cut trees and stumps under 10 inches DBH <4 inches.
7. No conifers within 25 feet of dripline of black oak and small oaks in cluster regeneration.

### **Performance Measures for Hand Cutting and Hand Piling**

Each of these gets a rating of 1 if acceptable for a total of 12 points possible.

1. Number of residual trees under 10 inches DBH remaining on a per acre basis (20 trees per acre).
2. Spacing of residual trees under 10 inches DBH remaining (45-50' spacing).
3. Selection of leave trees (species priority and DBH): JP/PP > SP >RF> DF > IC > WF>LP. No hardwoods > 4 inches DBH, big leaf maple, elderberry, dogwood, Pacific yew, and California Hazelnut removed.
4. Health of residual tree (straightest bole, free of damage due to insects, disease, physical and mechanical causes).
5. No snags less than 10 inches DBH present. Snags >24 inches DBH felled and left.
6. Stump height of cut trees and stumps under 10 inches DBH <4 inches.
7. No conifers within 25 feet of bole and dripline of black oak and small oaks in cluster regeneration.
8. Prune branches of all remaining conifers to 6-10 feet in height.
9. Placement/location of pile.

10. Dimension and structure of pile (includes clearing around piles and material in piles is less than 4' in length).
11. Plastic utilization/placement.
12. Any treated material that falls outside of unit boundary needs to be piled inside the unit.

### 3. Acceptance

Work on this contract will be deemed acceptable when an average score of 85% or higher is achieved. If the inspection score is less than 85%, the unit is not accepted and may be reworked. The unit may be reworked as many times as needed and then reinspected. If the Contractor elects to not rework a unit with an inspection score below 85%, 2% of the performance bond will be deducted for that unit for each percentage point below 85%.

### 4. NFF Inspections

NFF inspections are for the purpose of satisfying the Forest Service that the services are acceptable and do not relieve the Contractor of the responsibility for maintaining quality control.

NFF or the Forest Service will conduct all inspections. The Contractor (or designated representative) is encouraged to be present to observe inspections. Summary results will be made available on request.

**Compliance Inspections.** Visual compliance inspections will be made on a periodic basis. Such inspections are not final and do not constitute acceptance by the NFF.

**Final Inspections.** Final (formal) inspections for payment will be made on completed items only. Contractor shall request final inspections in writing and give NFF at least two working days advanced notice. Inspections will be completed within four working days after the notice is received. If the work is not ready for inspection at the time specified by the Contractor, the cost associated with the inspection attempt may be charged to the Contractor.

**Disputed Inspection.** The Contractor may request re-inspection without rework if the results are unacceptable. Re-inspection must be requested in writing within 48 hours after receiving written notice of the inspection results. Re-inspection will be accomplished within five working days after receipt of the contractor's written request.

The same sampling and inspection procedures will be used, but new samples will be taken. The inspection pattern will be shifted so that new samples will not overlap previously inspected samples. Results will be rounded to the nearest whole percent.

If re-inspection results are within five percentage points of the first inspection, the original inspection result will be used in determining acceptability and payment. If re-inspection results are greater than five percentage points above or below the first inspection, the re-inspection results will be used.

If the re-inspection results are within five percentage points of the first inspection, the Contractor shall pay the actual costs of the re-inspection.

**Re-inspection after Rework.** Where rework after a failed inspection may improve the inspection results, the Contractor may rework the area and request (in writing) a second inspection. Re-inspection will be accomplished within five working days after the notice is received. Areas not ready for re-inspection at the time specified by the Contractor will not be re-inspected, and the results of the first inspection will be final.

**APPENDIX F**  
**Timber Removal Specifications**

**Sleightville**

<b>F.1 – Location and Area -</b>			
This Stewardship Project Area of:	3,543	acres more or less are located in: Tahoe National Forest	<i>T19N, R08E, sections 24, 25 T19N, R09E, 13, 14, 15, 17, 19, 20, 21, 22, 23, 24, 27, 28, 29, 30, 21, 32. T19N, R10E Sections 11, 18</i>

**Sleightville**

**F.2 -Volume Estimate and Utilization Standards.**

Species	Product	Estimated Quantity	Unit of Measure	Minimum Specifications				
				Merchantable Tree		Piece Required to be Removed		
				Diameter Breast High (d.b.h.) (inches)	Number of Minimum Pieces per Tree	Length (feet)	Diameter Inside Bark at Small End (inches)	Net Merch. Factor <u>1/</u>
CS	Sawtimber	232,654	TON	10	1	10.5	6	12
OS	Non-Saw	6,799	TON	3	1	6	1	16
<b>Total Quantity</b>		239,453						

1/ Enter Merchantability Factor (Merch. Factor) or Net Scale in % of Gross Scale, whichever is appropriate.

**Sleightville**

**F.3- High Stumps.**

Species	Product	Maximum Stump Height (inches)
<u>All</u>	<u>All</u>	<u>12.0</u>

**F.4- Timber Rates. (Scaled)**

**Sleighville**

Cutting Unit Number	Approx. Acres	Species	Product	Quantity	Unit of Measure	Rate of Payment \$/UOM	Required Deposit per unit of measure
All	3,929.70	CS	Sawtimber	232,654	TON	0.00	0.00
All	4,500	OS	Non-Sawtimber	6,799	TON	0.00	0.00

**F.6 - Timber Designations.** Timber designated for cutting shall be confined to the Stewardship Project Area. No undesignated timber shall be cut without prior notification to and approval of the Forest Service. Prescriptions/timber designations are included later in this subsection.

	Number	Acres
Clearcutting Units		
Specified Road Clearing		
Overstory Removal Units		
Understory Removal Units		
Individual Trees		3,543
Incompletely Marked Timber		

**Sleighville**

**F.7 - Cutting Unit Boundary Designation.** The boundaries of cutting units are designated as shown in the following table. The trees used for boundary designation are not to be cut.

Cutting Unit/ Subdivision/Area /Payment Unit	Tree Paint Color	Designation or Specification
All	Green/ Blue	<u>Hazard Tree.</u> Notwithstanding B2.32 all dead and unstable live trees which are leaning towards a road or are otherwise hazardous to a road, and are sufficiently tall to reach Contractor's landings or the roadbed of National Forest System roads within Sale Area, shall be felled by Contractor when Marked in the specified paint color above and below stump height by Forest Service in advance of felling any other timber in the vicinity. Pieces meeting Utilization Standards from such dead and unstable live trees shall be removed unless Contractor is notified in writing that removal would cause unacceptable damage to areas requiring special protection such as residual timber, roads, administrative sites, streamside management zones,

		and areas identified on Sale Area Map or on the ground.
162, 167, 171, 173, 176, 187, 190, 193, 200, 201, 204, 207, 212, 213, 214, 229, 234, 236, 241, 242, 244, 252, 257, 260, 262, 266, 269, 271, 275, 313, 316, 319, 320, 322, 344, 379, 431, 434, 436, 447, 453, 550, 551, 552, 777	Blue	<u>Individual Tree Mark.</u> Individual trees are designated for cutting only if Marked above and below stump height with the specified paint color.
N/A		<u>Leave Tree Mark.</u> All live <b>Conifers</b> are designated for cutting unless Marked as leave trees. Leave trees are Marked above and below stump height with the specified paint color. Sale Area Map indicates areas plainly identified on the ground where leave trees are Marked to be left uncut.
All	Orange	<u>Wildlife Trees.</u> Notwithstanding the designation for cutting under B2.31, B2.33, B2.34, or B2.35, trees which are identified by standard Forest Service metal wildlife tree sign or painted with the specified paint color on the uphill and downhill side, shall be left uncut. In event such trees are destroyed in Contractor's Operations, Forest Service may designate alternate trees to be saved.
All	Black	<u>Marked Out Trees.</u> When it is necessary to delete previously marked trees, a unique tree marking paint color will be Marked over or adjacent to the original mark, but will not obscure the original marking. Trees Marked with the original marking paint color and the unique tree marking paint color are not Included Timber.
N/A		<u>Designation by Spacing C2.351#</u>
N/A		<u>Designation by Species and Diameter, C2.352#</u>
N/A		<u>Designation by Damage Class, C2.353#</u>
N/A		<u>Designation by Row Spacing, C2.354#</u>

<u>Subdivision/Payment Unit</u>	<u>Boundary Paint Color</u>	<u>Boundary Designation</u>
N/A		
<u>Cutting Unit</u>	<u>Boundary Paint Color</u>	<u>Boundary Designation</u>
N/A	Orange	Boundaries are marked with 2 <b>ORANGE</b> vertical spots facing into the subdivision and/or a single spot facing along the subdivision line and <b>ORANGE</b> paint below stump height. Where existing



		roads are used as subdivision boundaries, these are not painted.
--	--	--

**F.8 Tree Designation/Prescriptions**

**Mixed Conifer – Individual Tree Mark:**

Within Subdivision(s) or Cutting Unit(s) 28, 31, 33, 53, 128, 155, 162, 167, 169, 170, 171, 172, 173, 176, 179, 180, 182, 184, 186, 187, 189, 190, 191, 193, 200, 201, 204, 205, 207, 208, 212, 213, 215, 216, 229, 230, 232, 234, 235, 236, 239, 241, 242, 244, 245, 246, 247, 248, 252, 257, 259, 260, 262, 264, 265, 266, 267, 269, 271, 272, 273, 275, 278, 286, 294, 307, 308, 313, 314, 316, 319, 320, 322, 323, 342, 344, 345, 346, 348, 349, 371, 379, 383, 384, 385, 386, 430, 431, 434, 435, 436, 438, 442, 444, 445, 446, 447, 457, 551, 552, 666, and 777 as shown on the Sale Area Map. Cut trees are marked with blue tracer paint and have been designated to meet the below listed criteria.

**Plantation – Designation by Prescription:**

Within Subdivision(s) or Cutting Unit(s) 7, 10, 11, 30, 32, 57, 60, 63, 75, 90, 91, 96, 97, 101, 102, 108, 110, 118, 130, 138, 146, 147, 149, 150, 151, 154, 541, and 542 as shown on the Sale Area Map. The following criteria shall be used by Contractor to designate trees and other products for cutting and removal:

**Commercial Trees (≥10.0” diameter at breast height):**

- Through variable density thinning, leave an average basal area of:

Designation	Target BA (sqft/ac)	BA Range (sqft/ac)
Plantation	80	60 - 120
Mixed Conifer	160	120 - 180

- Sites near insect and disease centers will host basal areas on the lower end of the range.
- Higher BA may exist in retention areas but try to reduce fuels while maintaining structure wherever possible.
- Density should appropriately represent terrain and site productivity.
- Removal should focus on enhancing a groupy/clumpy stand structure.

Diameter Limits		Special Considerations for Hardwoods
		<ul style="list-style-type: none"> <li>• Minimize cutting of hardwoods to prevent resprouting.</li> <li>• For tanoak dominated stands, retain the largest trees with the highest crown ratios using a 25’ maximum spacing (as feasible) to allow for mechanical operability and fuels reduction while maintaining maximum canopy cover to mitigate re-sprouting growth response.</li> <li>• Consider leaving healthy conifers that overtop live oak and</li> </ul>
<b>Veg Type</b>	<b>DBH Limit</b>	
Conifers	29.9"	
Hardwoods	12"	

	madrone, maintaining overstory shade.
--	---------------------------------------

Species Retention Preference	Crown Position Retention Preference
<ol style="list-style-type: none"> <li>1. Hardwoods (black, live, tanoak, madrone)</li> <li>2. JP/PP</li> <li>3. SP</li> <li>4. RF</li> <li>5. DF</li> <li>6. IC</li> <li>7. WF</li> <li>8. LP</li> </ol> <div style="margin-left: 150px;">  <p style="margin-left: 20px;">Shade tolerant species</p> </div>	<ol style="list-style-type: none"> <li>1. Dominant</li> <li>2. Co-dominant</li> <li>3. Intermediate</li> <li>4. Suppressed</li> </ol> <p>*~70% of trees removed should come from the intermediate and suppressed classes, focusing on ladder fuel reduction</p>

Legacy Pines	Black Oaks										
<p>Remove shade tolerant trees within and beyond the dripline of healthy JP/PP and SP:</p> <table border="1" style="margin-left: auto; margin-right: auto;"> <thead> <tr> <th style="text-align: center;">DBH</th> <th style="text-align: center;">Removal Distance</th> </tr> </thead> <tbody> <tr> <td style="text-align: center;">≥30"</td> <td style="text-align: center;">50'</td> </tr> <tr> <td style="text-align: center;">24" - 29.9"</td> <td style="text-align: center;">30'</td> </tr> </tbody> </table>	DBH	Removal Distance	≥30"	50'	24" - 29.9"	30'	<p>Remove conifers within and beyond the dripline of healthy black oaks:</p> <table border="1" style="margin-left: auto; margin-right: auto;"> <thead> <tr> <th style="text-align: center;">DBH</th> <th style="text-align: center;">Removal Distance</th> </tr> </thead> <tbody> <tr> <td style="text-align: center;">≥12"</td> <td style="text-align: center;">25'</td> </tr> </tbody> </table>	DBH	Removal Distance	≥12"	25'
DBH	Removal Distance										
≥30"	50'										
24" - 29.9"	30'										
DBH	Removal Distance										
≥12"	25'										

**Units ≥10 acres (up to 10% of unit):**

- Group Selection – Create openings (1 to 3 acres) to increase heterogeneity, targeting all conifers 0" - 29.9" dbh except healthy hardwoods and pines, primarily utilizing areas exhibiting:
  - Disease or insect patches (i.e., severe heterobasidion root disease, white pine blister rust infection centers, pine beetle outbreaks, etc.)
  - Unnatural overstocking of shade tolerant species (i.e., southern aspect slopes and ridgetops)
  - Where probability of successful recruitment of a new cohort is high (i.e., a substantial number of hardwoods or pines can be released, or a seed source for pines exists).
  
- Group Retention – Reserve pockets (up to 1 acre) of large trees or important wildlife features (i.e., snags, down logs, oaks with cavities, and pockets of dense vegetation with multiple canopy layers).

- Minimize retention areas around large pine trees, oaks that would benefit from release, or in areas that inhibit operations, ingress egress, WUI effectiveness or treatment effectiveness.
- Some archeological sites, riparian conservation areas, and other protected resource areas that are flagged for avoidance may be considered as retention areas.
- Tree Health – Retention priority should be based on tree health, then species preference, followed crown position and tree size. This will allow for structural variability while leaving the healthiest trees available.
  - Leave tree live crown ratio should be  $\geq 40\%$ , show little evidence of insects or disease, and exhibit minimal crown and bole damage.
    - Special consideration should be taken to remove SP if there is evidence of white pine blister rust in the canopy or bole.
  - Consider retaining a healthy smaller tree of comparable size (within 8-10" dbh) over a larger, unhealthy tree.
  - Consider retaining a healthy competing species over an unhealthy pine.
  - Consider leaving trees with higher canopy base height.

**Non-Commercial Trees (3-9.9" DBH):**

- Leave an average of 20 healthy trees per acre (approximately 40-45' spacing) of various size.
- Species preference should be the same as above with exceptions based on overstory stand conditions (e.g., don't leave understory trees if they're susceptible to spread of disease from overstory trees).
- Minimize cutting of hardwoods to prevent resprouting.

**F.9- Control of Operations**

**B6.3 - CONTROL OF OPERATIONS.** Under this contract, "Contractor's Operations" shall include activities of or use of equipment of Contractor, Contractor's employees, agents, contractors, Subcontractors, or their employees or agents, acting in the course of their employment in operations hereunder on National Forest system lands or within Forest Service protection boundary (unless acting under the immediate supervision of Forest Service). Contractor's Operations shall be conducted in a workmanlike and orderly manner. The timing of required Forest Service designation of work on the ground and the performance of other Forest Service work shall not be such as to cause unnecessary delay to Contractor.

**C6.22# - PROTECTION OF IMPROVEMENTS.** (5/2008) Contractor shall notify Forest Service at least **10** days prior to any operations in the vicinity of improvements identified on Sale Area Map. Contractor shall protect such improvements from damage and shall be responsible for their timely restoration if damaged by Contractor's Operations. If relocation or removal of said improvements is necessary to avoid foreseeable damage by Contractor's Operations, work and cost shall be borne by the party listed in the table below. If Contractor is required to move

or relocate the improvements, they shall move or relocate the improvements listed in the following table to locations and in a manner as specified in drawings or in specifications attached hereto. Improvements shall be returned to their original locations following Contractor's Operations.

See table below for improvements to be protected.

SPECIFICATIONS PURSUANT TO C6.22# – PROTECTION OF IMPROVEMENTS.

<u>Improvement</u>	<u>Owner's or Permittee's Name</u>	<u>Timing</u>	<u>Specifications</u>	<u>Work and Cost of Removal or Relocation Borne by</u>
All infrastructure present in campgrounds	USFS	10 Days	Move, Remove, and Replace	Contractor

C6.24# – SITE SPECIFIC SPECIAL PROTECTION MEASURES. (4/04) Special protection measures needed to protect known areas identified on Sale Area Map or on the ground include:

Cultural Resource Protection Measures: No timber removal or equipment is permitted within areas identified as requiring standard resource protection measures. These areas are flagged with black and blue or red and black diagonally striped flagging. Unless agreed upon by a Forest Service (FS) heritage professional in writing, no equipment will be allowed within cultural resource boundaries. Activities within cultural resource boundaries will be prohibited except for using developed Forest Service transportation roads after a qualified heritage professional has reviewed and approved that use.

Linear sites can be crossed or breached by equipment where their features or characteristics lack integrity. Crossings and/or breaches will be identified and clearly marked by a FS heritage professional.

Trees will be directionally felled away from cultural resource flagged boundaries. Felling and removal of hazard, salvage, and other trees within cultural resource boundaries may occur using rubber-tired loaders, crane/self-loader, helicopter, or other non-disturbing methods after review and approval by a FS heritage professional.

Road maintenance and reconstruction of developed FS transportation roads that bisect a cultural resource must be approved by a FS heritage professional.

Cultural resource location and boundary marking information will be conveyed to Forest Service employees responsible for project administration and/or implementation. This information may be conveyed to contractors outside of the FS who are responsible for project administration and/or implementation after a confidentiality agreement has been signed by contractors, partners,

and a FS heritage professional.

Wildlife and Botanical Protection Measures: As shown on the Sale Area Map: No operations permitted within zone flagged with Orange/White candy stripped flagging with “Special Treatment Zone” or Orange with “Noxious Weeds” in Black letters. Trees to be felled away from flagged zone. No equipment will be allowed within the boundaries. Slash will not be deposited within the Controlled Area.

For the protection of aquatic species: at any water drafting site, the use of a FGM 5161 or other similar foot valve with openings less than 2mm will be required. Additionally, the foot valve shall be placed in the deepest section of the water source on a shovel or a plastic/canvas bucket, after the site has been inspected for frogs or their eggs.

No operations will be permitted during and within the identified Limited Operating Periods as shown on the Sale Area Map.

Cave Resource Protection Measures: N/A

**C6.315# - SALE OPERATIONS SCHEDULE.** (8/2006) Unless otherwise agreed in writing, Contractor’s Operations shall be performed in accordance with the following schedule:

Subdivision/ Area/Unit	Conditions of Operation	Purpose
30, 96, 138, 146, 151, 184, 204, 232, 234, 239, 245, 247, 259, 265, 278, 316, 322, 435, 436, 447, 777	No operations from 3/1 to 8/15. Subject to change based on yearly survey.	To protect the California spotted owl.
149, 191, 272, 430	No operations from 2/15 to 9/15. Subject to change based on yearly survey.	To protect the Goshawk
All Units	During the wet season (defined as starting with the first frontal rain system that deposits a minimum of 0.25 inches of rain on or after October 15th and ending April 15th), no ground disturbance or prescribed burning (underburning and pile burning) would occur within 300 feet of suitable breeding habitat for California redlegged frog for 72 hours following a rain event.	To Protect Red Legged Frog
All	Skidding operations will only be permitted when soil moisture conditions are such that compaction, gulying, and/or rutting will be minimal. Equipment may operate on designated skid trails when soils are dry to a minimum of 4 inches. Low-ground pressure equipment may operate off of designated skid trails when soils are dry to a depth of 4 inches. High-ground pressure equipment may operate off of designated skid trails when soils are dry to a depth of 8 inches. Off of designated skid trails, limit all equipment passes over the same piece of ground to reduce the potential	To protect soil from compaction, gulying, and/or rutting.

	for adverse soil compaction. Outside Normal Operating Season (NOS) or during wet periods within the NOS, utilize the TNF Wet Weather Operations Guidelines.	
--	---	--

C5.35# – ROAD AND WATER SUPPLY USE. (5/2008) National Forest water supply locations, access, method of filling trucks, period of water availability and procedures designed to maintain water quality at each location shall be agreed in advance of use. Such use shall at no time reduce water supplies to the level that further use may be detrimental to aquatic resources or other established use. Waterholes and other improvements relating to said water supplies shall be put into condition, prior to expected seasonal periods of precipitation or runoff, to avoid resource damage.

Damage to resources at such locations caused by Contractor's Operations, other than fire suppression activities, shall be repaired by Contractor in a timely and agreed manner to the extent practicable to restore and prevent further resource damage.

Unless otherwise agreed, Contractor's use of roads and other water supply requirements shall conform to the following table.

SPECIFICATIONS PURSUANT TO C5.35# - REQUIREMENTS OF ROAD AND WATER SUPPLY USE

Load Limitations	<p>Contractor shall notify Forest Service in writing of the planned size and load distribution for equipment which exceeds the State of California Vehicle Code legal size and weight, and the National Forest System roads to be used. Such notice may be part of plan of operation. Within 15 days after receipt of the written notice Forest Service shall notify Contractor in writing of any regulations or restrictions that may be needed to protect National Forest Transportation Facilities.</p> <p>A written permit shall be required for moving any vehicle which is in excess of the established legal size and weight which is not listed in the above plan, except as may be authorized in prior written agreements.</p>
Existing Non-National Forest System Roads	Roads not shown on Sale Area Map may be used as Temporary Roads if there is agreement before use is started.
Snow Removal	<p>If Contractor removes snow from roads, such work shall be done with Forest Service approval and in a manner that will protect roads and adjacent resources.</p> <p>Snow berms shall be removed or placed to avoid accumulation of melt water on the road and prevent water concentration on erosive slopes or soils.</p> <p>Snow must not be removed to the road surface. A minimum 3 inch snow depth must be left to protect the roadway. If the road surface is damaged, Contractor shall replace lost surface material and repair structures damaged in blading operations prior to hauling, unless climatic conditions prevent necessary work from being accomplished or as otherwise agreed in writing.</p>

	<p>Single lane roads shall be plowed full width including turnouts. In event double lane roads are not plowed to full width, warning signs shall be required and plowing shall be no less than single lane (12 feet) with intervisible turnouts.</p>																				
<p>Water Supply Deposits</p>	<p>If Contractor utilizes the water site located <b>N/A</b>, for any listed activity, Contractor shall make deposit with Forest Service for that activity at the time and in the amount shown in the Water Supply Deposit Schedule table below.</p> <p style="text-align: center;"><b>WATER SUPPLY DEPOSIT SCHEDULE</b></p> <table border="1" style="width: 100%; border-collapse: collapse;"> <thead> <tr> <th style="width: 25%;">Activity</th> <th style="width: 15%;">Unit of Payment</th> <th style="width: 15%;">Unit Cost</th> <th style="width: 15%;">Total Cost</th> <th style="width: 20%;">Time of Payment</th> </tr> </thead> <tbody> <tr> <td> </td> <td> </td> <td> </td> <td> </td> <td> </td> </tr> <tr> <td colspan="5" style="text-align: center;"><b>N/A</b></td> </tr> <tr> <td> </td> <td> </td> <td> </td> <td> </td> <td> </td> </tr> </tbody> </table>	Activity	Unit of Payment	Unit Cost	Total Cost	Time of Payment						<b>N/A</b>									
Activity	Unit of Payment	Unit Cost	Total Cost	Time of Payment																	
<b>N/A</b>																					
<p>Surface Replacement Deposits</p>	<p>Contractor shall make Required Deposits for deferred surface replacement (16 U.S.C. 537) for use of existing surfaced roads. If applicable, such deposits shall be based upon the volume and distance hauled on the roads and at the applicable rates listed in the table below titled Surface Replacement Deposit Schedule. If Contractor uses surfaced roads under jurisdiction of Forest Service other than those listed, Forest Service may establish applicable rates for such surfaced roads.</p> <p style="text-align: center;"><b>SURFACE REPLACEMENT DEPOSIT SCHEDULE</b></p> <table border="1" style="width: 100%; border-collapse: collapse;"> <thead> <tr> <th style="width: 15%;">Road No.</th> <th style="width: 15%;">From</th> <th style="width: 15%;">To</th> <th style="width: 15%;">Miles</th> <th style="width: 20%;">Rate</th> </tr> </thead> <tbody> <tr> <td> </td> <td> </td> <td> </td> <td> </td> <td> </td> </tr> <tr> <td> </td> <td> </td> <td> </td> <td> </td> <td> </td> </tr> <tr> <td> </td> <td> </td> <td> </td> <td> </td> <td> </td> </tr> </tbody> </table> <p style="text-align: center;">Sale Area Average Rate: \$____/MBF, CCF or Ton</p>	Road No.	From	To	Miles	Rate															
Road No.	From	To	Miles	Rate																	

**B6.4 - CONDUCT OF LOGGING.** Unless otherwise specifically provided herein, Contractor shall fell trees designated for cutting and shall remove the portions that meet Utilization Standards, as provided in F.2, prior to acceptance of subdivision for completion of logging under Appendix E – Inspection and Acceptance of Service Work Items. Forest Service may make exceptions for occasional trees inadvertently not cut or trees or pieces not removed for good reason, including possible damage to forest resources or gross economic impracticability at the time of removal of other timber. Logging shall be conducted in accordance with the following, unless C6.4 provisions set forth requirements to meet special or unusual logging conditions.

**C6.41# – FELLING, BUCKING, AND LIMBING.** (8/2007) Unless otherwise agreed in writing, Contractor’s felling, bucking, and limbing operations shall be conducted as specified in the table below.

**SPECIFICATIONS AND TREATMENTS PURSUANT TO C6.41# - FELLING, BUCKING AND LIMBING (8/2007)**

Treatment Method and Applicable Map Symbol	Felling, Bucking and Limbing Specifications
Limbing	Outside of construction clearings, Clearcutting Units and regeneration units, unless otherwise provided by B6.414, Contractor shall, prior to skidding/yarding operations, cut exposed limbs from products which are to be skidded/yarded. Such limbing of stems shall be done to a top diameter of approximately 3 inches, at which point the top shall be cut from the remainder of the stem.
No Lop “No Lop”	Within units or subdivisions designated NO LOP on Sale Area Map, trees shall be skidded/yarded to agreed landing locations prior to lopping.
Whole Tree Yarding “Whole”	Notwithstanding the requirements above, within units or subdivisions designated “Whole” on Sale Area Map, trees smaller than <b>27</b> inches DBH shall be skidded/yarded to agreed landing locations prior to limbing, bucking, and lopping. Trees larger than or equal to <b>27</b> inches DBH shall be bucked into two or more pieces with the butt portion being no longer than <b>41</b> feet prior to skidding/yarding. The butt log shall not be limbed prior to skidding/yarding.
Directional Felling “DF”	Within areas designated DF on Sale Area Map, Included Timber shall be directionally felled away from stream courses, structures, survey monuments, and private property, and controlled areas with the use of specialized equipment. Such directional felling shall not be required when in the faller’s judgment it is unsafe to do so, and shall be left standing.

Maximum Log Length  
Cut trees shall be bucked prior to skidding so that resulting logs shall not exceed the maximum log length including trim allowance shown in following table:

Unit Number	Maximum Log Length
All	41’

Minimum Stump Height	Unit/Subdivision	Minimum Stump Height (inches)	Purpose or Reason
	N/A	3 inches	Facilitate timber accountability

**C6.42# - GROUND BASED SKIDDING.** (8/2006) Unless otherwise agreed in writing, the method of skidding Included Timber shall be as shown on the Sale Area Map, by areas, with symbols defined in the following table:

Map Symbol	Requirements
TRAC	Skid road pattern shall be agreed in advance of felling and main skid roads shall be flagged on the ground in advance of felling. Contractor shall stage-



	<p>log by felling and skidding Included Timber in two or more separate operations when necessary to prevent undue damage to the resources or residual stand. Needed tractor trails shall be constructed in advance of skidding.</p> <p>Products shall be end-lined as needed to protect resources or residual timber from unnecessary damage. The number of chokers shall be limited as necessary to avoid unnecessary damage to resources or residual timber. By agreement, tractors may be used to separate products to prevent stain</p>
SUSP	Products shall be skidded with leading end clear of ground.
SPACE	Skid roads will average 75 feet from center to center, except where converging.
ENDL	Endlining shall not be required for distances in excess of <b>75</b> feet uphill, and <b>100</b> feet downhill.
MAX	Tractors used for skidding outside Clearcutting Units, regeneration units or other authorized clearings, shall be of the type (rubber-tired or track-laying) shown on the Sale Area Map and shall not exceed the overall width designated on Sale Area Map.
MH	<p>Contractor shall cut Included Timber and move it to designated skid trails using equipment with a boom having an operating radius of at least <b>20</b> feet for bunching trees, capable of severing, lowering and placing trees up to <b>24</b> inches diameter at stump height on the ground prior to skidding. Such equipment must be capable of operating on slopes up to <b>40%</b>.</p> <p>Notwithstanding above, hand felling using chainsaws may be required in or adjacent to sensitive areas to protect resources from unnecessary damage.</p> <p>Trees which exceed capability of specified equipment may be felled, bucked and skidded in a manner consistent with the requirements of B6.41 - Felling and Bucking, C6.41# - Felling, Bucking, and Limbing Requirements and the above "TRAC", "SUSP", "SPACE", "ENDL", and "MAX" requirements.</p>
CTL	N/A
PB	N/A
HCTL	N/A

CABLE AND SKYLINE YARDING. (8/2007) Unless otherwise agreed in writing, requirements for cable and skyline yarding equipment are listed in the table below, with the following symbols. Yarding systems are subject to change upon agreement between Contractor, NFF, and Forest Service:

CS - Cable yarding specified.

CR - Be capable of yarding from roadway with additional landing excavation to accommodate the yarder held to a minimum consistent with safe yarding operations.

CW - Meet all of above requirements using a swing-boom type yarder.

SY - All yarding except lateral yarding, shall be accomplished by a skyline system, which supports products clear of the ground across Buffer Strips and in other areas yard with one product end suspended.

SL - Meet all of above requirements, have lateral yarding capability to hold skyline carriage stationary until products are yarded to skyline corridor.

SR - Meet all of above requirements and be capable of yarding from roadway with additional landing excavation to accommodate the yarder held to a minimum consistent with safe yarding operations.

SW - Meet all of above requirements using a swing-boom type yarder.

For SL, SR, and SW areas, locations of all skyline corridors shall be by agreement and designated on the ground. Such agreement shall be prior to felling unless ground and timber conditions otherwise justify. Width of said skyline corridors shall be kept to a practicable minimum consistent with the related silvicultural prescription.

For all yarding methods, if rigging must be slung on undesignated live trees, these trees shall be protected from damage by special steel plates, nylon tail-hold slings or similar effective protective devices.

Swing Yarding. In areas designated with the following labels on the Sale Area Map, the following requirements are included, unless otherwise agreed in writing:

**“Tractor Swing”** – all Included Timber shall be tractor skidded from yarder landing to loading areas shown on Sale Area Map or other agreed locations.

**“Skyline Swing”** – all Included Timber shall be skyline yarded from tractor skidded area to a skyline yarding landing. Location of tractor and skyline landings shall be agreed upon prior to skidding and yarding operations.

Unit	Yarding Method
11, 57, 91, 97, 128, 155, 167, 169, 171, 184, 186, 191, 201, 208, 239, 241, 246, 252, 260, 264, 265, 266, 267, 272, 275, 278, 286, 319, 320, 342, 345, 371, 383, 385, 430, 434, 435, 457, 551, 552, 666, 777	CS or CR or SY or SR

C6.429 - HELICOPTER YARDING. (8/2007) Within subdivisions/payment units so designated on Sale Area Map, yarding shall be by a helicopter capable of lifting and transporting products to landings without unnecessary damage to residual trees.

Unless otherwise agreed in writing, the following conditions apply to this sale:

Purchaser is not required to cut trees if there is insufficient volume to make a turn of at least 100 cubic feet net scale (500 board feet net scale) within a 100 foot radius from the largest tree.

If trees that would have been exempt from cutting as described above are cut, pieces meeting minimum specifications in F.2 shall be removed, scaled and paid for.

Areas where flight pattern is restricted are shown on the Sale Area Map, and include all Limited Operating Periods. Logs and other external loads shall not be flown over these areas or during the seasonal limited operating periods identified in C6.315.

**B6.5 - STREAMCOURSE PROTECTION.** “Streamcourses” that are subject to provisions of this Section are shown on Sale Area Map and on harvest cards. Unless otherwise agreed, the following measures shall be observed to protect Streamcourses:

(a) Contractor’s Operations shall be conducted to prevent debris from entering Streamcourses, except as may be authorized under paragraph (d). In event Contractor causes debris to enter Streamcourses in amounts that may adversely affect the natural flow of the stream, water quality, or fishery resource, contractor shall remove such debris as soon as practicable, but not to exceed 2 days, and in an agreed manner that will cause the least disturbance to Streamcourses.

(b) Culverts or bridges shall be required on Temporary Roads at all points where it is necessary to cross Streamcourses. Such facilities shall be of sufficient size and design and installed in a manner to provide unobstructed flow of water and to minimize damage to Streamcourses. Trees or products shall not be otherwise hauled or yarded across Streamcourses unless fully suspended.

(c) Wheeled or track-laying equipment shall not be operated in Streamcourses, except at crossings designated by Forest Service or as essential to construction or removal of culverts and bridges.

(d) Flow in Streamcourses may be temporarily diverted only if such diversion is necessary for contractor’s planned construction and Forest Service gives written authorization. Such flow shall be restored to the natural course as soon as practicable and, in any event, prior to a major storm runoff period or runoff season.

**B6.6 - EROSION PREVENTION CONTROL.** Contractor’s Operations shall be conducted reasonably to minimize soil erosion. Equipment shall not be operated when ground conditions are such that excessive damage will result. Contractor shall adjust the kinds and intensity of erosion control work done to ground and weather conditions and the need for controlling runoff. Erosion control work shall be kept current immediately preceding expected seasonal periods of precipitation or runoff. If contractor fails to do seasonal erosion control work prior to any seasonal period of precipitation or runoff, NFF may temporarily withhold payment of invoices.

**C6.6# - EROSION PREVENTION AND CONTROL.** (5/2008) Erosion prevention and control work, including Stream course protection, required by B6.5 and B6.6 shall be completed within 15 calendar days after skidding operations related to each landing are substantially completed or after Forest Service designation on the ground of work where such designation is required hereunder. Said time limit shall be exclusive of full days lost in contractor's Operations due to causes beyond contractor's control. Such on the ground designation shall be done as promptly as feasible unless it is agreed that the location of such work can be established without marking on the ground. After September 15 and as long

thereafter as operations continue the work shall be done as promptly as practicable. Damage resulting from contractor's operations due to failure to perform required work shall be repaired by contractor.

Notwithstanding other provisions in this contract and unless otherwise agreed in writing, any hay, straw, or mulch used in this contract shall be State of California certified weed free.

Additional erosion control requirements of this contract are listed in the following table.

SPECIFICATIONS PURSUANT TO C6.6# - EROSION PREVENTION AND CONTROL.  
(5/2008)

**Vegetative Soil Stabilization: N/A**

**Special Erosion Prevention Measures:** Contractor shall give adequate treatment by spreading slash or wood chips or by agreement giving other treatment to portion of tractor roads, skid trails, landings, cable yarding corridors, tractor-end lined corridors and Temporary Road fills where necessary to supplement other erosion prevention measures required elsewhere in this contract. In no event shall contractor be required to treat more acres than that shown in the legend of Sale Area Map. The specific locations to be treated shall be designated on the ground by Forest Service. These special erosion prevention measures are to be done within the same date and time periods as stated above.

**Soil Scarification: N/A**

**Backblading:** Within recreation development sites and public use areas designated on Sale Area Map, contractor shall, at Forest Service request, backblade skid trails in lieu of cross ditching.

C6.7# - SLASH TREATMENT. (8/2006) Contractor shall pile, scatter, yard, construct firelines or otherwise treat slash defined in specifications below, within designated areas. Work required of Contractor shall be in accordance with the following slash plan and specifications, and the Sale Area Map.

All vegetative debris associated with construction of Specified Roads such as unutilized timber, brush and grubbed stumps is Construction Slash. Measures to be taken by Contractor for treatment of Construction Slash are set forth in the attached road construction specifications and in the attached slash treatment specifications.

Vegetative debris larger than 1 inch in diameter outside bark and 3 feet long resulting from Contractor's Operations, other than Construction Slash, is Logging Slash. Measures to be taken by Contractor for treatment of Logging Slash are set forth below unless otherwise agreed in writing.

Forest Service and Contractor shall jointly develop a schedule for completion of slash treatment on the various portions of Sale Area prior to Contractor's Operations.

Removing may be substituted for treatment of any other specified method.

By agreement in writing, certain slash may be left for fuelwood. When the specified treatment is by a combination of methods, Logging Slash not treated by one of the methods shall be treated by the other(s).

See the slash treatment specification table below.

SPECIFICATIONS PURSUANT TO C6.7# - SLASH TREATMENT (8/2006)

Specified slash treatment methods shall be shown on Sale Area Map or listed in the following tables by the following symbols:

Slash Treatment Methods

Symbol	Method	Definition
Buck-L	"Bucking Large Logging Slash"	Tops and limbs over 4 inches diameter outside bark (d.o.b.), not to be otherwise treated, shall be bucked into lengths not to exceed 6 feet, unless agreed otherwise.
Buck-P	"Bucking and Piling"	Logging Slash smaller than <N/A> inches and larger than 4 inches in large end d.o.b. shall be bucked into lengths not to exceed <N/A> feet and left in place. Logging Slash 4 inches and smaller in large end d.o.b. shall be hand Piled within Required Disposal Strip for Forest Service disposal.
Bury	"Burying"	Logging Slash shall be buried where agreed in borrow areas, pits, trenches, or other locations reasonably near the area of origin. Logging Slash shall be matted down in layers and shall be covered with at least 2 feet of rock and soil so that the final surface is sloped to drain and relatively smooth.
Chip	"Chipping"	Chippable Logging Slash up to 4 inches in d.o.b. shall be processed through a chipping machine. Chips shall be scattered to a loose depth not exceeding 6 inches.
Deck	"Decking" Large material	Logging Slash 10 inches or larger in large end d.o.b. and 10 feet or more in length shall be Decked for disposal by Forest Service by piling pieces parallel to each other.
Mach	"Machine Piling"	Concentrations of Logging Slash, excluding scattered individual pieces, shall be Machine Piled by tractor equipped with brush rake for disposal by Forest Service.
Pile	"Piling" Small material	Logging Slash smaller than 10 inches in large end d.o.b. and 10 feet long shall be hand Piled for disposal by Forest Service.
Remove	"Removing"	Logging Slash shall be moved or hauled to locations shown on Sale Area Map and designated on the ground where it shall be piled for disposal by Forest Service.
Scat 18" Scat 30"	"Scattering"	Logging Slash shall be scattered to reduce slash concentrations with slash being generally left within 18 or 30 inches of the ground as shown on Sale Area Map. Logging Slash shall be

scattered into openings away from and without unnecessary damage to residual trees. All scattered logs shall be limbed, placed away from trees and positioned so they will not roll. When Scattering is specified, another method may be used by agreement.

Stack	“Stacking” Small material	Logging Slash 10 inches or smaller in large end d.o.b. and 8 feet or more in length shall be stacked for disposal by Forest Service by piling pieces parallel to each other.
Fell	“Damaged Small Trees”	Unless treated under other provisions, all trees smaller than the minimum d.b.h., over 5 feet in height, and damaged beyond recovery by Contractor's Operations shall be felled. Such trees shall be limbed to a stem diameter outside bark of approximately 3 inches, at which point the top shall be cut from the remainder of the stem, and shall be bucked into lengths not exceeding 20 feet.

**UNIT AND SUBDIVISION SLASH TREATMENT SPECIFICATIONS**

SLASH TREATMENT		
Subdivision or Unit No	Specified Method	Prohibited Method
All	Chip, Fell, SCAT-18”, YUML	All other

LANDINGS AND DISPOSAL SITES. Unutilized logs accumulated at landings and disposal sites shall be Decked by Contractor for disposal by Forest Service. The maximum height of decks is shown in the following table. Other slash accumulated at landings and disposal sites shall be kept separate from unutilized logs and treated by the method shown in the following table.

SLASH TREATMENT			
	Subdivision or Unit No.	Specified Method	Maximum Height of Decks
Landings	ALL	Cover, Deck, Mach	10
Disposal Sites	N/A		

**TREATMENT ALONG PERMANENT ROADS** Permanent roads that require roadside slash treatment are listed in the attached table and shown on Sale Area Map. All Logging and Construction Slash within Required Disposal Strips shall be treated by Contractor. "Required Disposal Strips" are those areas adjacent to permanent roads where slash treatment is required for resource objectives. The width of Required Disposal Strips is shown in the attached table and is measured in slope distance from Roadbed edges of permanent roads. By agreement, in Clearcutting Units and regeneration units slash from Required Disposal Strips may be treated with other Logging Slash. By agreement the location of Required Disposal Strips may be adjusted from side to side without materially changing the total work required.

Slash treatment in Required Disposal Strips shall be accomplished without affecting the proper functioning of channels leading to and from drainage structures.

Logging Slash larger than treatment size requirements of the specified method shall either be Scattered outside Required Disposal Strip, within Required Disposal Strip or Decked at agreed locations as shown in the attached table.

			SLASH TREATMENT	
Road No.	Road Junctions (From To)	Width of Required Disposal Strip	Specified Method	Slash Larger Than Treatment Size Requirements of Specified Method
N/A				
N/A				

**TREATMENT ALONG TEMPORARY ROADS.** Outside of Clearcutting Units or regeneration units, all trees felled or pushed over and trees damaged beyond recovery by Temporary Road construction shall be felled, limbed to a stem d.o.b. of approximately 3 inches, at which point the top shall be cut from the remainder of the stem, and stem shall be bucked into lengths not exceeding <6> feet. Such slash shall be Scattered free of soil to reduce concentrations unless treatment is required by another specified method.

**ADDITIONAL SLASH TREATMENT REQUIREMENTS.** Within areas shown on Sale Area Map, Contractor shall perform work according to the specifications in the attached Table, unless otherwise agreed in writing.

Subdivision	Additional Slash Treatment Requirements
All mechanized cutting units	<p>Yard all stem material to a top d.o.b. of 1 inch, from timber designated for cutting, with the following exception: broken portions of logs and tops less than 4 feet in length need not be yarded. Broken ends of merchantable logs shall not be bucked off in the units.</p> <p>Slash and Substandard Material accumulated at the landings shall be Decked or Machined Piled, in accordance with specifications above.</p> <p>Material accumulated at landings shall be considered as Timber Subject to Agreement under F.2, described as Substandard Material and may be removed and paid for at Contractor's option.</p>

View “Visible Slash Treatment” Designated on Sale Area Map with boundaries posted on the ground are **roads/trails** with distance limitations for visible slash treatment. Within such units and the area of visible Logging Slash adjacent thereto, Logging Slash shall be treated by Contractor. Primary treatment shall be by Removing, Burying, Chipping, Piling, Machine Piling, or a combination of these means unless a method is specified or prohibited on Sale Area Map. Logging Slash not readily treated by the selected or specified method shall be removed to designated areas or treated as agreed.

YUMD “Yarding Unutilized Material-Decking” All unutilized material developed by Contractor’s Operations shall be treated by the d.o.b. and length specifications as shown in the unit specification table. All unutilized material shall be Yarded to landings and Decked. Where this is impractical, or other reasons, other locations shall be agreed upon.

Unit	Large End d.o.b. (in)	Length (feet)
<N/A>		

YUME “Yarding Unutilized Material-Exterior Boundary” All unutilized material developed by Contractor’s Operations shall be treated by the d.o.b. and length specifications as shown in the unit specification table. All unutilized material shall be yarded to locations a minimum of 50 feet slope distance within the exterior boundaries of such units and positioned so the yarded material will not roll.

Unit	Large End d.o.b. (in)	Length (feet)
<N/A>		

YUML “Yarding Unutilized Material-Landing” All unutilized material developed by Contractor’s Operations shall be treated by the d.o.b. and length specifications as shown in the unit specification table. All unutilized shall be yarded to locations within 100 feet slope distance of landing. Where this is impractical, or other reasons, other locations shall be agreed upon.

Unit	Large End d.o.b. (in)	Length (feet)
<b>All</b>	15	10

YUMR “Yarding Unutilized Material-Removal” All unutilized material developed by Contractor’s Operations shall be treated by the d.o.b. and length specifications as shown in the unit specification table. All unutilized shall be removed to locations shown on Sale Area Map and designated on the ground, or other agreed locations, and Decked.

Unit	Large End d.o.b. (in)	Length (feet)
<N/A>		

Cover “Covering Piles” All piles shall be covered with a durable waterproof covering as approved by Forest Service. The material shall be at least six feet in width. Piles shall not be less than fifty percent covered, with the covering extending not less than half way down all



sides. Pieces of burnable material shall be placed on top of the durable waterproof covering to keep the covering from blowing off the pile.

**C6.815 – THIRD PARTY SCALING SERVICES.** (4/04) Notwithstanding the requirement for Forest Service or parties under contract to Forest Service to provide Scaling services under B6.81, Scaling designated in F.4 shall be conducted by a third party Scaling organization approved by Forest Service. Scaling shall be done in accordance with agreed upon Scaling specifications and NFF shall bear costs for Scaling service.

In the event third party Scaling service is suspended for causes such as strikes, termination of third party’s approval to Scale National Forest logs by Forest Service, or NFF’s failure to pay third party Scaling costs, hauling operations shall be suspended until agreed alternate Scaling services are provided or service by third party is resumed.

When an approved alternate Scaling location pursuant to B6.811 does not have an approved third party scaling organization as a commonly used Scaling services provider, Forest Service or parties under contract to Forest Service shall provide Scaling services at the approved alternate location. In such an event, the cost of waived third party Scaling listed in F.4 shall be charged to Timber Sale Account.

If Forest Service and NFF agree in writing that another party under contract to Forest Service will perform Scaling, the contract will be modified to include C6.816 and Timber Sale Account will be charged for such Scaling.

**OBLITERATION OF LANDINGS** – Unless otherwise agreed in writing, landings shall be obliterated after the removal of sawtimber, non-saw timber, and biomass, or after the preparation of piles for burning if material can’t be removed. Landings shall be decommissioned via tillage or blocking depending on site specific conditions of each landing. Unless otherwise agreed in writing, tillage will be to a depth of 12 inches on up to 400 acres.

**F.10 - Roads.** The CONTRACTOR is/are authorized to construct and maintain roads, bridges, and other transportation facilities, as needed for conducting treatments on National Forest and other lands where Forest Service has such authority. As used in this Supplemental Project Agreement, “construct” includes “reconstruct.”

<b>F.10-a– Specified Roads.</b>							
Name and Date of Governing Road							
Specifications:							
Road No.	Project Name	Design Class	Approx. Length (mi./km.)	Sheet Numbers and Approval Date	Performance Responsibility		
					Survey	Design	Const. Staking
34	Jouberts	S-5	12.06				
34-02	Pourier Creek	S-5	0.06				
34-02-01	Pourier Creek Spur	S-5	0.2				
34-03	Pourier Creek Spur	S-5	1.8				
34-04	Jouberts Spur	S-5	0.3				

34-05 Seg 1	Indian Hill North	S-5	0.18				
34-05 Seg 2	Indian Hill North	S-5	0.37				
34-06	Jouberts Spur	S-5	0.17				
34-07	Jouberts Spur	S-5	1.71				
34-07-01	Skinner Spur	S-5	0.2				
34-08	Upper Indian Creek	S-5	2.16				
34-09	Little Humbug	S-5	0.3				
34-09-01	Little Humbug Spur	S-5	0.46				
34-11	Twin Quartz Spur	S-5	0.3				
34-13-01	Twin Quartz Spur	S-5	0.53				

**F.10-b - Road Maintenance Requirements.** Contractor shall maintain roads in accordance with the following Road Maintenance Requirements. Additional details are included in the Sleighville Roads Package.

## Road Maintenance Requirements (C5.31#)(B5.3)

Timber Sale: Sleightville Stewardship Agreement

Sheet 1 of 1

					Applicable Road Maintenance Specifications																													
					Prehaul								During								Posthaul													
					T	T	T	T	T	T	T	T	T	T	T	T	T	T	T	T	T	T	T	T	T	T	T	T	T	T	T	T	T	T
					8	8	8	8	8	8	8	8	8	8	8	8	8	8	8	8	8	8	8	8	8	8	8	8	8	8	8	8	8	8
					0	0	0	0	0	0	0	0	0	0	0	0	0	0	0	0	0	0	0	0	0	0	0	0	0	0	0	0	0	0
Phase	Road Number	From	To	Miles	1	2	3	4	5	6	7	9	1	1	1	2	3	4	5	6	7	1	2	3	4	5	6	7	8	9	1	1		
I	293-02 Seg 1	MP 2.36	MP 2.95	0.59			P		P		P						P			P														
I	293-02 Seg 2	MP 0.0	MP 1.96	1.96			P		P		P						P			P														
I	293-02-02	MP 0.75	MP 2.62	1.87			P		P		P						P			P														
II, III	293-18	MP 0.0	MP 4.08	4.08			P		P		P						P			P														
II, III	293-18-05-01	MP 0.0	MP 1.36	1.36			P		P		P						P			P														
II, III	293-18-08	MP 0.0	MP 0.96	0.96			P		P		P						P			P														
III	34-08-03	MP 0.0	MP 0.40	0.40			P		P		P						P			P														
II, III	34-13	MP 0.24	MP 2.00	1.86			P		P		P						P			P														
II	34-15	MP 1.88	MP 2.58	0.70			P		P		P						P			P														
II	34-15-01	MP 0.0	MP 0.84	0.84			P		P		P						P			P														
I	49-22	MP 0.0	MP 0.60	0.60			P		P		P						P			P														
I, II, III	34	MP 0.0	MP 12.06	12.06			P	P	P		P						P			P														
I	34-01 Seg 1	MP 1.81	MP 0.0	1.81			P		P		P						P			P														
I	34-01 Seg 2	MP 1.93	MP 2.4	0.47			P		P		P						P			P														
I	34-02	MP 0.0	MP 0.45	0.45			P		P		P						P			P														
I	34-03 Seg 1	MP 0.72	MP 0.0	0.72			P		P		P						P			P														
I	34-03 Seg 2	MP 1.04	MP 1.80	0.76			P		P		P						P			P														
I	34-04	MP 0.0	MP 0.30	0.3			P		P		P						P			P														
III	34-05 Seg 1	MP 0.0	MP 0.38	0.38			P		P		P						P			P														
III	34-05 Seg 2	MP 1.09	MP 1.20	0.11			P		P		P						P			P														
I, III	34-06	MP 0.0	MP 1.10	1.1			P		P		P						P			P														
II	34-07	MP 0.57	MP 1.71	1.14			P		P		P						P			P														
II, III	49-27	MP 0.0	MP 1.02	1.02			P		P		P						P			P														
I	34-02-02	MP 0.0	MP 0.34	0.34			P		P		P						P			P														
I	34-02-01	MP 0.0	MP 0.19	0.19			P		P		P						P			P														
III	34-08-02	MP 0.0	MP 0.20	0.2			P		P		P						P			P														
II	34-07-01	MP 0.0	MP 0.20	0.2			P		P		P						P			P														
II, III	34-09	MP 0.0	MP 0.20	0.2			P		P		P						P			P														
II, III	34-09-01	MP 0.0	MP 0.24	0.24			P		P		P						P			P														
II	34-11	MP 0.0	MP 0.30	0.3			P		P		P						P			P														
II	34-13-01	MP 0.0	MP 0.53	0.53			P		P		P						P			P														
III	34-08 Seg 1	MP 2.16	MP 2.32	0.16			P		P		P						P			P														
III	34-08 Seg 2	MP 0.0	MP 2.17	2.17			P		P		P						P			P														
I, III	293-02-03	MP 0.0	MP 1.20	1.2			P		P		P						P			P														
II, III	34-12	MP 0.0	MP 0.60	0.6			P		P		P						P			P														
I, III	293-02-02-02	MP 0.75	MP 1.00	0.25			P		P		P						P			P														

P = Maintenance work to be performed by the purchaser  
 S = Maintenance work where the costs will be shared with the Forest Service  
 Maximum volume of Purchasers responsibility for slide and slump repair is N/A cubic yards (T-810)  
 Appraisal estimate for surfacing repair equals 2315 tons of aggregate. (T-804)  
 Appraisal estimate for surfacing repair equals 10 tons of AC patch. (T-804)

**F.10-c - Use of Roads By the Contractor.** Contractor’s use of existing roads identified on Stewardship Project Area Map by the following codes is prohibited or subject to restrictive limitations, unless agreed to otherwise:

Code	Use Limitations
X	Hauling prohibited
R	Hauling restricted
U	Unsuitable for hauling prior to completion of agreed reconstruction
P	Use prohibited
A	Public use restriction
W	Regulation waiver

Roads coded A will be signed by the Forest Service to inform the public of use restrictions. The NFF's use of roads coded R, A, or W shall be in accordance with the following restrictions:

**Restricted Road List**

Road Number	Road Name	Termini		Map	Description of Restrictions
		From	To	Legend	

<b>F.11– Scaling Instructions and Specifications.</b>	
Name and Date of Governing Instructions:	FSH 2409.11a, National Forest Cubic Log Scaling Handbook, as amended and supplemented. Governing instructions for products contained in E.2.

<b>F.12– Scaling Services.</b>					
Species	Product	Unit of Measure	Site and Geographic Location	Method	Standard Estimated Cost per Unit \$
ALL	ALL	TON		100% Weight	0.00

**F.13 - Advance Deposits.** The NFF agree(s) to make advanced deposits in advance of cutting. These deposits may be in the form of cash, acceptable payment bond, earned stewardship credit or any combination thereof. Advanced deposits will be in such amounts as to maintain an unobligated balance sufficient enough to cover the value of timber to be cut. Forest Service and Contractor will agree on a systematic approach to provide sufficient advanced deposits.

If the credit balance in the IRSA is less than the amount due for timber, the Forest Service will suspend all or any part of NFF's operations until payment or acceptable payment guarantee is received.

#### **F.14- Title Passage.**

Scaled. All right, title, and interest in and to any included timber shall remain with the Forest Service until it has been cut, scaled, and removed from the Stewardship Project Area or other authorized cutting area, and paid for, at which time title shall then vest with NFF. Timber cut under cash deposit or acceptable payment guarantee shall be considered to have been paid for. Title to any included timber that has been cut, scaled and paid for, but not removed from the Stewardship Project Area or other authorized cutting area by the NFF on or prior to the termination date, shall remain with the Forest Service.

#### **F.15- Liability.**

Liability for Loss. If Included Timber is destroyed or damaged by an unexpected event that significantly changes the nature of Included Timber, such as fire, wind, flood, insects, disease, or similar cause, the party holding title shall bear the timber value loss resulting from such destruction or damage; except that such losses after removal of timber from the Stewardship Project Area, but before scaling, shall be borne by NFF at current SPA Rates and Required Deposits. Deterioration or loss of value of salvage timber is not an unexpected event.

In the event Included Timber to which Forest Service holds title is destroyed, NFF will not be obligated to remove and pay for such timber. In the event Included Timber to which Forest Service holds title is damaged, the Forest Service shall make an appraisal to determine for each species the difference between the appraised unit value of Included Timber immediately prior to the value loss and the appraised unit value of timber after the loss. Current SPA Rates in effect at the time of the value loss shall be adjusted by differences to become the redetermined rates. There shall be no obligation for the Forest Service to supply, or for NFF to accept and pay for, other timber in lieu of that destroyed or damaged. This Subsection shall not be construed to relieve either party of liability for negligence.

#### **Limited Liability for Operations Fires.**

Maximum Amount of NFF's Obligation per Operation's Fire. Entry should be determined as follows and rounded up to the nearest \$100. The minimum amount will be \$1,000.00. If State statute or law defines limited liability, use that determination (e.g. Oregon), otherwise calculate the amount using the following formula:

$[(1) \times (2) + (3) \times (4)] \times (5) = \text{Maximum Amount of Cooperator's Obligation per Operations Fire. Round up to the next \$100.}$

(1) Equals the number of workers normally required to operate the size of proposed project.

4 Workers

(2) Equals the daily (12 hour) wage rate for semi-skilled (AD-1) firefighter.

$$\text{\$16.08/Hr.} \times 12 \text{ hours} = \text{\$192.96}$$

(3) Equals the number of pieces of equipment normally required to operate the size of proposed project that can effectively cut and clear fire lines.

3 Pieces of equipment

(4) Average daily rate for each piece of equipment, including cost of operator, from current local engineering cost guide.

$$\text{\$350.00/Hr.} \times 12 \text{ hours} = \text{\$4,200.00/12hr.}$$

(5) Equals the number of days normally required to control and mop up such fires to a point where control lines can reasonably be expected to hold under foreseeable conditions. Minimum is one day and maximum is 10.

5 days

**Cooperator's Obligation per Operations Fire,**

**Maximum**

**Amount:**           \$ 67,000

## **APPENDIX G GUIDELINES FOR OPERATIONS**

The following Guidelines for Operations apply to activities under this contract, when relevant to the project. These guidelines are intended to clarify the expectations of the parties related to these specific areas of operations.

1. **Stewardship Project Area Map (Map).** This is the boundary of the Stewardship Project Area as shown in Appendix C and designated on the ground by the Forest Service to meet the anticipated needs of the parties. The following are identified on the Map:
  - a) Identified patented claims.
  - b) Boundaries of all harvest and stewardship treatment units.
  - c) Diameter limits for overstory and understory removal units.
  - d) Areas where leave trees are marked to be left uncut.
  - e) Specified roads.
  - f) Roads where log hauling or use is prohibited or restricted.
  - g) Roads and trails to be kept open.
  - h) Improvements to be protected.
  - i) Locations of known wildlife or plant habitat and cave resources to be protected.
  - j) Locations of areas known to be infested with specific invasive species of concern.
  - k) Maximum stump heights when more than one height is listed by areas.
  - l) Skidding or yarding methods.
  - m) Streamcourses to be protected.
  - n) Locations of temporary roads to be kept open.
  - o) Payment units, if required.
2. **Use of Roads by the Partner.** CONTRACTOR is/are authorized to use existing National Forest system roads and specified roads. The Parties will determine that such use will not cause damage to the roads or National Forest resources.
3. **Plan of Operations for Roads.** Annually, prior to start of operations, CONTRACTOR will prepare a supplement to the Technical Proposal that shall include a schedule of proposed maintenance and construction progress and a description of planned measures to be taken to provide erosion control for work in progress, including special measures to be taken on any segments of construction not substantially completed prior to periods of seasonal precipitation or runoff. The CONTRACTOR shall submit a revised schedule when they propose a significant deviation from the progress schedule. Prior to beginning construction on any portion of specified roads identified as sensitive on plans, the parties shall agree on the proposed method of construction and maintenance.
4. **Protection of Residual Trees.** The CONTRACTOR's operations shall not unnecessarily damage young growth or other trees to be reserved.
5. **Safety.** The CONTRACTOR's operations shall facilitate the Forest Service's safe and practical inspection of CONTRACTOR's operations and conduct of other official duties on

the Stewardship Project Area. The CONTRACTOR has/have all responsibility for compliance with safety requirements for CONTRACTOR's employees.

When operations are in progress adjacent or on Forest Service controlled roads and trails open to public travel, CONTRACTOR shall furnish, install, and maintain all temporary traffic controls that provide the user with adequate warning of hazardous or potentially hazardous conditions associated with operations occurring in the area. The parties shall agree to a specific traffic control plan prior to commencement of work. Devices shall be appropriate to current conditions and shall be covered or removed when not needed.

During periods of general recreation activity within Stewardship Project Area or vicinity, the Forest Service may restrict road construction, timber cutting, yarding, and other harvesting operations to days other than Saturdays, Sundays, and holidays.

## **LOGGING AND MAINTENANCE OPERATIONS SIGNING STANDARDS**

All signs must be manufactured & installed as specified in the FHWA "**Manual on Uniform Traffic Control Devices**" (MUTCD) & FS publication "**Standards for Forest Service Signs & Posters**"( EM 7100-15).

### **SIGN STANDARDS**

**SHAPE & COLOR:** Generally, signs for logging and maintenance operations are either diamond-shaped or rectangular. All signs are **reflective orange background with black legend and border** unless shown otherwise. Handpainted, homemade signs are not legal. Fluorescent paint is not reflectorized.

**SUBSTRATE:** Sign substrate material may be High Density Overlay (HDO) Plywood, Aluminum, Fiberglass Reinforced Plastic, Corrugated Plastic or Roll-up Fabrics.

**SIGN SIZE:** Sign size is a factor of speed and MUTCD & FS standards. Where conditions of speed, volume, or special hazard require greater visibility or emphasis, larger signs should be used. Minimum sizes for the most common signs can be found in Figure 4. Refer to the EM-7100-15 for additional sign sizes.

**LEGEND:** All lettering shall be Series "C" alphabet, conforming to Standard Alphabets for Highway Signs. Letter size is also a function of speed - use letter size and word messages as specified in MUTCD and EM-7100-15.

### **SIGN PLACEMENT**

Signs are to be installed in locations as agreed to in the traffic control plan. All signs are to be removed, covered, or folded when operations are not in progress or the sign message is not applicable. Signs should generally be located on the right-hand side of the roadway. When special emphasis is needed, signs may be placed on both the left and right sides of the road. Sign message shall be clearly visible to road users, mounted on posts or portable sign



stands.

**LATERAL CLEARANCE**

From the edge of the road - 2 foot minimum, where slope limits to less than 6 feet. 6-12 foot preferred.

**HEIGHT**

Minimum of 7 feet, measured from the bottom of the sign to the near edge of the travelway. The height to the bottom of a supplemental sign mounted below the primary sign will be 6 feet.

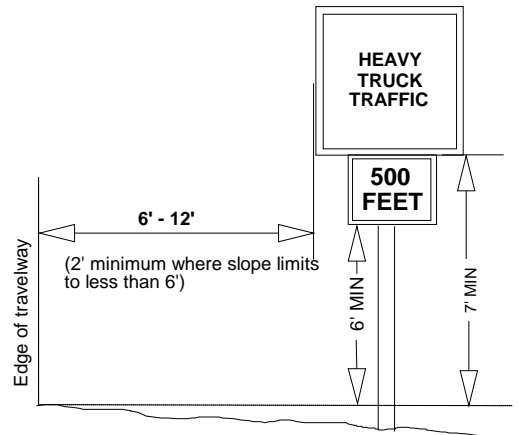

Figure 1: Sign Placement

Dimensions

**PLACEMENT DISTANCE**

Signs must be located 100-500 feet prior to the activity, (both ends if a through road) and maintained at that distance. This distance is based on speed. Refer to Figure 2 , Table II-1, MUTCD, a portion of which is reproduced here, to determine correct placement distance.

Posted or 85 percentile speed MPH	Deceleration to listed advisory speed MPH				
	10	20	30	40	50
20	NA				
25	100				
30	150	100			
35	200	175			
40	275	250	175		
45	350	300	250		
50	425	400	325	225	
55	500	475	400	300	
60	575	550	500	400	300
65	650	625	575	500	375

Figure 2: A Portion of MUTCD TABLE II-1

**SIGN SUPPORTS**

**POSTS:** Signs are to be mounted on separate posts. Supplemental signs such as Speed Advisory plates are to be mounted on the same post as the primary sign. **Do not mount signs on trees or other signs.** Posts may be wood, metal, carsonite or similar material. Where sign supports cannot be sufficiently offset from the road edge, supports will meet breakaway standards. Single wood posts with less than 24 square inches do not require breakaway design.

**TEMPORARY/PORTABLE SUPPORTS:** Portable supports may be used for short-term, short-duration, and mobile conditions. MUTCD defines this time period as one work shift, 12 hours or less. All portable supports must meet MUTCD standards, including breakaway. These must be a minimum of 1 foot above the road surface or more if visibility requires it.

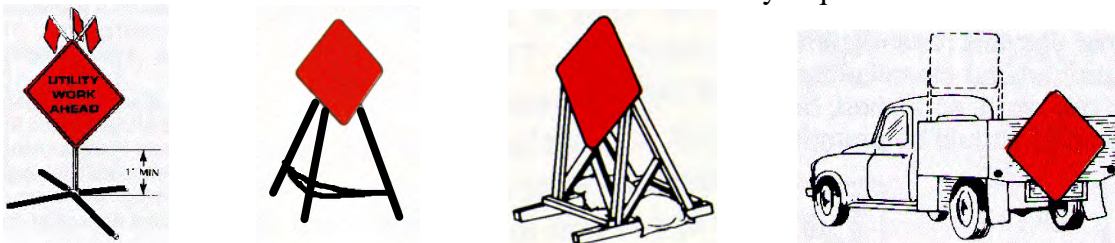

Figure 3: Examples of Temporary/Portable Supports

## SIGNS

The following signs meet the intent of the Safety standard. *This is not a complete listing of signs that may be needed.*



FG20-1-48\*  
FW22-3-30

FG20-2-48

FG20-3-42\*

FG20-3a-42



FW20-1-30\*

W21-3-30\*

FW21-4a-30

FW11-7-24

W22-1-36\*



FW8-6-24  
24\*

FW11-9a-24

W7-3a-24\*

W13-1-18\*\*

W20-7aP-

\* Specify Distance

Speed

\*\* Specify



BM-L-O



BM-R-O

Barricade Markers (See MUTCD for length and stripe size)

6. **Safety (Timber Hauling).** The CONTRACTOR shall secure all products transported by truck with at least two chain or cable wrappers over the load, such wrappers being securely fastened to effectively contain every bolt or log in at least two places.
7. **Accident and Injury Notification.** The CONTRACTOR shall notify Forest Service of any lost time personal injury accident or any accident or vandalism resulting in personal property damage over \$400 in value that occurs as a result of or is associated with CONTRACTOR's Operations.

The CONTRACTOR shall notify Forest Service within 8 hours of any personal injury accident. For vandalism and personal property accidents, CONTRACTOR shall notify Forest Service at the same time notification is given to the state and local law enforcement authorities.

The CONTRACTOR shall take all reasonable measures after an accident or vandalism event to preserve the scene of the incident and provide information to facilitate a Forest Service investigation.

8. **Sanitation and Servicing.** The CONTRACTOR shall take all reasonable precautions to prevent pollution of air, soil, and water by CONTRACTOR's operations. Precautions shall include if facilities for employees are established on the Stewardship Project Area, they shall be operated in a sanitary manner. The parties shall agree to the cleanup and restoration of a polluted site. The CONTRACTOR shall maintain all equipment operating on Stewardship Project Area in good repair and free of abnormal leakage of lubricants, fuel, coolants, and hydraulic fluid. The CONTRACTOR shall not service tractors, trucks, or other equipment on National Forest lands where servicing is likely to result in pollution to soil or water. The CONTRACTOR shall furnish oil-absorbing mats for use under all stationary equipment or equipment being serviced to prevent leaking or spilled petroleum-based products from contaminating soil and water resources. The CONTRACTOR shall remove from National Forest lands all contaminated soil, vegetation, debris, vehicle oil filters (drained of free-flowing oil), batteries, oily rags, and waste oil resulting from use, servicing, repair, or abandonment of equipment.
9. **Prevention of Oil Spills.** If CONTRACTOR maintain(s) storage facilities for oil or oil products on the Stewardship Project Area, CONTRACTOR shall take appropriate preventive measures to ensure that any spill of such oil or oil products does not enter any stream or other waters of the United States or any of the individual States. If the total oil or oil products storage exceeds 1,320 gallons in containers of 55 gallons or greater, CONTRACTOR shall prepare a Spill Prevention Control and Countermeasures Plan. Such plan shall meet applicable EPA requirements (40 CFR 112), including certification by a registered professional engineer. The CONTRACTOR shall notify the Forest Service and appropriate agencies of all reportable (40 CFR 110) spills of oil or oil products on or in the vicinity of the Stewardship Project Area that are caused by CONTRACTOR's employees, agents, contractors or their employees or agents, directly or indirectly, as a result of CONTRACTOR's operations. The CONTRACTOR will take whatever initial action may be safely accomplished to contain all spills.

10. **Hazardous Substances.** The CONTRACTOR shall notify the National Response Center and Forest Service principal contact of all releases of reportable quantities of hazardous substances on or in the vicinity of the Stewardship Project Area that are caused by CONTRACTOR's employees, agents, contractors or their employees or agents, directly or indirectly, as a result of CONTRACTOR's operations, in accordance with 40 CFR 302.
11. **Washing Equipment.** In order to prevent the spread of noxious weeds into the Stewardship Project Area, CONTRACTOR shall be required to clean all off-road logging and construction equipment **prior** to entry on to the Stewardship Project Area. This cleaning shall remove all soil, plant parts, seeds, vegetative matter, or other debris that could contain or hold seeds. Only logging and construction equipment so cleaned and inspected by the CONTRACTOR will be allowed to operate within the Stewardship Project Area. All subsequent move-ins of equipment to the Stewardship Project Area shall be treated in the same manner as the initial move in. "Off-road equipment" includes all logging and construction machinery, except for log trucks, chip vans, service vehicles, water trucks, pickup trucks, cars, and similar vehicles.

The CONTRACTOR shall employ whatever cleaning methods are necessary to ensure that off-road equipment is free of noxious weeds. Equipment shall be considered free of soil, seed, and other such debris when a visual inspection does not disclose such material. Disassembly of equipment components or specialized inspection tools is not required.

As agreed upon, CONTRACTOR shall inspect equipment at cleaning location, and provide documentation of inspection to the Forest Service.

New infestations of noxious weeds, of concern to Forest Service and identified by either CONTRACTOR or Forest Service, on the Stewardship Project Area or on the haul route, shall be promptly reported to the other party. The CONTRACTOR and Forest Service shall agree on treatment methods to reduce or stop the spread of noxious weeds when new infestations are found. A current list of noxious weeds of concern to Forest Service is available at each Forest Service office.

12. **Conduct of Logging.** Unless otherwise specifically provided herein, CONTRACTOR shall fell trees designated for cutting and shall remove the portions that meet Utilization Standards, prior to acceptance of work for completion of logging and stewardship projects. Forest Service may make exceptions for occasional trees inadvertently not cut or trees or pieces not removed for good reason, including possible damage to forest resources or gross economic impracticability at the time of removal of other timber.
13. **Felling and Bucking.** Felling shall be done to minimize breakage of included timber and damage to residual timber. Unless agreed otherwise, felling shall be done by saws or shears. Bucking shall be done to permit removal of all minimum pieces. The CONTRACTOR may buck out cull material when necessary to produce pieces meeting utilization standards. Such bucked out material shall contain a minimum amount of sound wood, not in excess of the net

scale in percentage of gross scale, or based on the merchantability factor. If necessary to assess extent of defect, CONTRACTOR shall make sample saw cuts or wedges.

14. **Felling in Clearings.** Insofar as ground conditions, tree lean, and shape of clearings permit, trees shall be felled so that their tops do not extend outside clearcutting units, construction clearings, and areas of regeneration cutting.
15. **Stump Heights.** Stumps shall not exceed, on the side adjacent to the highest ground, the maximum heights set forth in Appendix F except that occasional stumps of greater heights are acceptable when CONTRACTOR determine(s) that they are necessary for safe and efficient conduct of logging. Unless otherwise agreed, CONTRACTOR shall re-cut high stumps so they will not exceed heights specified in F-3 and shall dispose of severed portions in the same manner as other logging debris. The stump heights shown in Appendix F were selected with the objective of maximum reasonable utilization of the timber, unless the Map shows special areas where stump heights are lower for aesthetic, land treatment, or silvicultural reasons.
16. **Bucking Lengths.** Trees shall be bucked in various lengths to obtain the greatest utilization of material meeting utilization standards.
17. **Limbing.** The CONTRACTOR shall cut exposed limbs from products prior to skidding, as necessary to minimize damage to the residual stand during skidding. The CONTRACTOR may leave uncut those limbs that cannot be cut with reasonable safety.
18. **Skidding and Yarding.** Methods of skidding or yarding specified for particular areas, if any, are indicated on the Map. Outside clearcutting units and construction clearings, insofar as ground conditions permit, products shall not be skidded against reserve trees or groups of reproduction and tractors shall be equipped with a winch to facilitate skidding.
19. **Rigging.** Insofar as practicable, needed rigging shall be slung on stumps or trees designated for cutting.
20. **Landings and Skid Trails.** Location of all landings, tractor roads, and skid trails shall be agreed upon prior to their construction. The cleared or excavated size of landings shall not exceed that needed for efficient skidding and loading operations.
21. **Arches and Dozer Blades.** Skidding tractors equipped with pull-type arches or dozer blades wider than tractor width or C-frame width, whichever is greater, shall not be used in residual timber outside clearcutting units and other authorized clearings, except on constructed tractor roads or landings, unless there is written agreement that residual timber will not be damaged materially by such use.
22. **Protection of Streamcourses.** The CONTRACTOR's Operations shall be conducted to prevent debris from entering streamcourses, except as may be authorized under paragraph (d). In event CONTRACTOR cause(s) debris to enter streamcourses in amounts that may adversely affect the natural flow of the stream, water quality, or fishery resource,

CONTRACTOR shall remove such debris as soon as practicable, but not to exceed 2 days, and in an agreed manner that will cause the least disturbance to streamcourses.

- a) Culverts or bridges shall be required on Temporary Roads at all points where it is necessary to cross Streamcourses. Such facilities shall be of sufficient size and design and installed in a manner to provide unobstructed flow of water and to minimize damage to streamcourses. Trees or products shall not be otherwise hauled or yarded across streamcourses unless fully suspended.
- b) Wheeled or track-laying equipment shall not be operated in streamcourses, except at crossings agreed to by CONTRACTOR and the Forest Service or as essential to construction or removal of culverts and bridges.
- c) Flow in streamcourses may be temporarily diverted only if such diversion is necessary for CONTRACTOR's planned construction and Forest Service gives written authorization. Such flow shall be restored to the natural course as soon as practicable and, in any event, prior to a major storm runoff period or runoff season.

**23. Erosion Prevention and Control.** CONTRACTOR's operations shall be conducted reasonably to minimize soil erosion. Equipment shall not be operated when ground conditions are such that excessive damage will result. The CONTRACTOR shall adjust the kinds and intensity of erosion control work done, to ground conditions and weather conditions and the need for controlling runoff. Erosion control work shall be kept current immediately preceding expected seasonal periods of precipitation or runoff.

Prior to periods of accelerated water runoff, especially during the spring runoff and periods of heavy rainfall, CONTRACTOR shall inspect and open culverts and drainage structures, construct special cross ditches for road runoff, and take other reasonable measures needed to prevent soil erosion and siltation of streams.

Unless otherwise agreed in writing, CONTRACTOR shall complete erosion prevention and control work, including streamcourse protection, within 15 calendar days after completion of skidding and/or yarding operations for each landing.

Designation of on the ground work shall be done as promptly as feasible unless it is agreed that the location of such work can be established without marking on the ground.

During periods of accelerated water runoff, especially during the spring runoff and periods of heavy rainfall, CONTRACTOR shall inspect and open culverts and drainage structures, construct special cross ditches for road runoff, and take other reasonable measures needed to prevent soil erosion and siltation of streams.

When operations are active, erosion control work will be kept current and will be completed as soon as practicable.

**24. Protection of Improvements.** So far as practicable, CONTRACTOR shall protect specified roads and other improvements (such as roads, trails, telephone lines, ditches, and fences):

- a) Existing in the operating area,

- b) Determined to have a continuing need or use, and
- c) Designated on the Map.

The CONTRACTOR shall keep roads and trails needed for fire protection or other purposes and designated on the Map reasonably free of equipment and products, slash, and debris resulting from CONTRACTOR's operations. The CONTRACTOR shall make timely restoration of any such improvements damaged by CONTRACTOR's operations and, when necessary because of such operations, shall move such improvements.

25. **Meadow Protection.** Reasonable care shall be taken to avoid damage to the cover, soil, and water in meadows shown on the Map. Vehicular or skidding equipment shall not be used on meadows, except where roads, landings, and tractor roads are approved. Unless otherwise agreed, trees felled into meadows shall be removed by endlining. Resulting logging slash shall be removed where necessary to protect cover, soil, and water.
26. **Wetlands Protection.** Wetlands requiring protection under Executive Order 11990 are shown on the Map. Vehicular or skidding equipment shall not be used in such wetlands, except where roads, landings, and tractor roads are approved.
27. **Temporary Roads.** As necessary to attain stabilization of roadbed and fill slopes of temporary roads, CONTRACTOR shall employ such measures as outsloping, drainage ditches, and water-spreading ditches. After a temporary road has served CONTRACTOR's purpose, CONTRACTOR shall give notice to the Forest Service and shall remove bridges and culverts, eliminate ditches, outslope roadbed, remove ruts and berms, effectively block the road to normal vehicular traffic where feasible under existing terrain conditions, and build cross ditches and water bars, as staked or otherwise agreed to. When bridges and culverts are removed, associated fills shall also be removed to the extent necessary to permit normal maximum flow of water.
28. **Temporary Roads to Remain Open.** All bridges and culverts shall remain in place and ditches shall not be eliminated on Temporary Roads, shown as "Remained Open on the Map. All drainage structures shall be left in functional condition.
29. **Landings.** After landings have served CONTRACTOR's purpose, CONTRACTOR shall ditch and slope them to permit water to drain or spread. Unless agreed to otherwise, cut and fill banks around landings shall be sloped to remove overhangs and otherwise minimize erosion.
30. **Skid Trails and Fire Lines.** The CONTRACTOR shall construct cross ditches and water-spreading ditches on tractor roads and skid trails, where needed to prevent erosion. By agreement, CONTRACTOR may use other comparable erosion control measures, such as backblading skid trails, in lieu of cross ditching.
31. **Current Operating Areas.** Where logging, road construction, or other stewardship project work is in progress but not completed, unless agreed to otherwise, CONTRACTOR shall, before operations cease annually, remove all temporary log culverts and construct temporary

cross drains, drainage ditches, dips, berms, culverts, or other facilities needed to control erosion. Such protection shall be provided, for all disturbed, unprotected ground that is not to be disturbed further prior to end of operations each year, including roads and associated fills, tractor roads, skid trails, and fire lines. When weather permits operations, CONTRACTOR shall keep such work on any additional disturbed areas as up to date as practicable.

32. **Erosion Control Structure Maintenance.** During the period of this Contract, CONTRACTOR shall provide maintenance of soil erosion control structures constructed by CONTRACTOR until they become stabilized, but not for more than one year after their construction.
33. **Slash Disposal.** CONTRACTOR's timing of product removal and preparatory work shall not unnecessarily delay slash disposal. Specific slash disposal measures to be employed by CONTRACTOR are stated in Appendix F.
34. **Scaling.** Scaling includes:
  - a) Various volume determination methods, such as log rule, sampling, measuring, linear measuring, counting, weighing, or another method or combination of methods;
  - b) Various sites, such as truck Scaling stations, rollways, weighing stations, woods landings, water Scaling stations, or other sites.
  - c) Various geographic locations.
35. **Scaling Services.** Scaling services shall be performed by Forest Service personnel or parties under contract to Forest Service, except that weighing services may be performed by personnel or parties approved by the Forest Service. Scaling shall be provided in accordance with the instructions and specifications in Appendix F. Scalers shall be currently certified to perform accurate Scaling services. The scaling services provided shall be selected exclusively by the Forest Service. Scaling services may be continuous, intermittent, or extended.
  - a) Continuous scaling services is scaling at one site five (5) 8-hour shifts a week, exclusive of Sundays and Federal holidays.
  - b) Intermittent scaling services are non-continuous scaling services.
  - c) Extended scaling services are scaling services exceeding continuous scaling services and may include Sundays and designated Federal holidays.

As mutually agreed to by the parties, the Forest Service may provide other services, such as but not limited to grading, tagging, or marking of Scaled logs.

36. **Scaling Location.** The Forest Service shall provide scaling services at the scaling site(s) shown in Appendix F. The Scaling site(s) shown in Appendix F normally will be a non-exclusive site where more than one National Forest CONTRACTOR may be served. The CONTRACTOR may request, in writing, an alternate scaling site, such as at a private mill yard, private truck ramp, or a privately operated log transfer facility. The Forest Service may approve an alternate scaling site, when the Forest Service determines that scaling conditions at an alternate site are acceptable. Such conditions shall include at a minimum:



- a) Scaler safety and comfort,
- b) Product accountability and security,
- c) Facilities and practices conducive to accurate and independent Scaling, and
- d) The ability to provide for remote check Scaling.

Upon approval of an alternate scaling site, the Forest Service and CONTRACTOR shall enter into a written memorandum of agreement governing Scaling at that alternate location. The CONTRACTOR agree(s) that Forest Service personnel or persons under contract with the Forest Service shall perform scaling services at an alternative scaling site. In no instance shall CONTRACTOR perform scaling services.

37. **Scaling Adjustments.** The Forest Service shall check the accuracy of the scaling performed on National Forest logs. Scaling will be satisfactory if performed within the accuracy standards in governing instructions identified in Appendix F. In the event the Forest Service check scale(s) shows a variance in net scale in excess of the allowable variance, an adjustment to volume reported scaled may be made by the Forest Service. Such adjustment will be based on the difference between Forest Service check Scale(s) and original Scale for SPA volume Scaled within the adjustment period. The volume to which this difference will be applied will be:
- a) One-half of the volume Scaled between the last satisfactory check Scale and the first unsatisfactory check Scale or, if a period of 120 days or more occurs without Scaling National Forest timber for stumpage, the adjustment will be applied to 100 percent of the volume Scaled after this period and
  - b) 100 percent of the volume Scaled between unsatisfactory check Scales and
  - c) One-half of the volume Scaled between the last unsatisfactory check Scale and the next satisfactory check Scale, or if no satisfactory check Scale is completed and a period of 120 days or more occurs without Scaling of National Forest timber for stumpage, the adjustment will be applied to 100 percent of the volume Scaled since the last unsatisfactory check Scale.

Adjustments may increase or decrease the original Scaled volume. Adjustments will be applied to Integrated Resource Account to correct charges for Included Timber, plus deposits, Scaled during the adjustment period.

38. **Weighing Services.** Weighing services for stumpage payment purposes may be provided by either public or privately owned and operated weighing facilities. A "Weighing Services Agreement," approved by the Forest Supervisor, must be executed at each weighing facility providing weighing services.

Scales used to weigh National Forest products for payment purposes must be a currently certified scale in accordance with State law and be capable of weighing the entire load of logs in a single operation. The weighing of less than the entire load or weighing two loads at once is prohibited. Unless otherwise agreed, the minimum sized weighing facility shall be a 60-ton capacity scale with a 10 foot by 70 foot platform or larger. The weighmaster must work in a position where it is possible to verify that the truck wheels are on or off the scales. Weighing facilities shall meet the following minimum requirements:

- a) Be an electronic design,
- b) Use electronic load cells or have a fully enclosed and sealed weigh-beam,
- c) Have digital weight meters sealed with a seal approved by the State,
- d) Have a zero interlocking device on the printer,
- e) Have an automatic zero-setting mechanism,
- f) Have an automatic motion-detecting device,
- g) Be shielded against radio or electromagnetic interference, and
- h) Have a date and time stamp and gross and tare weights that print electronically with each weighing. The Forest Service may waive electronic printing for public or third party weighing facilities. The CONTRACTOR shall bear all charges or fees for weighing services.

39. **Presentation for Scaling.** The CONTRACTOR shall present products so that they may be Scaled in an economical and safe manner.

40. **Accountability.** When Scaling is performed away from Stewardship Project Area, products shall be accounted for in accordance with Forest Service written instructions, as follows:

- a) The CONTRACTOR shall plainly mark or otherwise identify products prior to hauling;
- b) Forest Service shall issue removal receipts to CONTRACTOR;
- c) The CONTRACTOR shall assign a competent individual at the landing to complete removal receipts and attach them to each load of products removed from Stewardship Project Area;
- d) Removal receipts shall be returned to Forest Service at periodic intervals;
- e) When products are in transit, the truck driver shall possess or display removal receipt and show it upon request as evidence of authority to move products;
- f) The scaler's portion of removal receipt shall be surrendered at point of Scaling, the unloading point, or as requested by Forest Service; and
- g) The CONTRACTOR shall notify Forest Service of lost or off-loaded logs and their location within 12 hours of such loss. The CONTRACTOR shall not place products in storage for deferred Scaling until an accountability system has been agreed to in writing for a stated period.

41. **Route of Haul.** As part of the annual Operating Schedule, CONTRACTOR shall furnish a map showing the route of haul over which unscaled products will be transported from the Stewardship Project Area to the approved Scaling location. Such route of haul shall be the shortest, most economical haul route available between the points.

Upon advance written agreement, other routes may be approved. All unscaled products removed from Stewardship Project Area shall be transported over the designated routes of haul. The CONTRACTOR shall notify Forest Service when a load of products, after leaving Stewardship Project Area, will be delayed for more than 12 hours in reaching Scaling location.

The CONTRACTOR shall require truck drivers to stop, if requested by Forest Service, for the following reasons:

- a) For accountability checks when products are in transit from Stewardship Project Area to the designated Scaling location or

- b) For a remote check Scale when products are in transit after being truck Scaled at the designated Scaling location.

The CONTRACTOR and Forest Service shall agree to locations for accountability checks and remote check Scales in advance of haul. Such locations shall be established only in areas where it is safe to stop trucks. The Forest Service shall notify CONTRACTOR of the methods to be used to alert truck drivers of an impending stop.

42. **Product Identification.** Before removal from the Stewardship Project Area, unless the Forest Service determines that circumstances warrant a written waiver or adjustment, CONTRACTOR shall:
- a) Hammer brand all products that are eight (8) feet or more in length and one-third (1/3) or more sound, on each end that is seven (7) inches or more in diameter.
  - b) West of the 100th meridian, paint with a spot of highway-yellow paint all domestic processing products that are eight (8) feet or more in length and one-third (1/3) or more sound, on each end that is seven (7) inches or more in diameter. Each paint spot must be not less than three (3) square inches in size.

The Forest Service shall assign brands and, if the Stewardship Project Area is within a State that maintains a log brand register, brands shall be registered with the State. The CONTRACTOR shall use assigned brand exclusively on logs under this SPA until Forest Service releases brand. The CONTRACTOR will furnish and apply highway-yellow paint of a lasting quality (oil-base or equivalent).

All hammer brands and/or highway-yellow paint must remain on logs until they are domestically processed. The CONTRACTOR shall replace identifying marks if they are lost, removed, or become unreadable. The CONTRACTOR may remanufacture products into different log lengths. Except for logs remanufactured as part of the mill infeed process immediately before processing, remanufactured products must be rebranded with the assigned SPA brand and repainted with highway-yellow paint, unless otherwise agreed to in writing by the Forest Service Representative. For such remanufactured products, Forest Service may approve use of a brand to be used exclusively as a catch brand, in lieu of the assigned SPA brand.

43. **Scaling Lost Products.** The volume of lost products shall be determined by the best methods currently available, using data from the records for the period in which the loss occurred or the most applicable period if loss should occur substantially after cutting. In the absence of specific information indicating size or species of lost products, species distribution and volume for entire truckloads shall be assumed to be the same as the average volume Scaled per truck during the report period, and for individual products it shall be assumed that the volume and species were the average volume of the highest priced species Scaled during the report period.

44. **Scaling Lost Sample Loads.** If Scaling is being done by sampling loads of logs, CONTRACTOR shall present such sample loads for Scaling by Forest Service. If loads of logs selected to be sample Scaled are placed in the decks before they are Scaled, they will be

considered as lost sample loads. It will be difficult, if not impossible, to determine the volume and species contained in such loads for payment purposes. Therefore, lost sample loads will be deemed to have a Scale volume and species composition equal to that of the highest value load Scaled during the sampling period, as established by Forest Service. If no sample loads were Scaled during the period, the Scale data for the high valued load will be taken from the most current preceding sampling period with Scale. Sample loads lost as a result of Forest Service actions shall be treated as non-Scaled loads.

45. **Scale Reports.** The Forest Service shall provide CONTRACTOR a copy of Forest Service scaler's record, if requested in writing.

46. **Fire Precautions and Control.**

- a) **Plans.** Prior to initiating CONTRACTOR's operations during Fire Precautionary Period, CONTRACTOR shall file with Forest Service a Fire Prevention and Control Plan providing for the prevention and control of fires on the Stewardship Project Area and other areas of CONTRACTOR's Operations. Such plan shall include a detailed list of personnel and equipment at CONTRACTOR disposal for implementing the plan. This requirement may be met by preparing a single plan for more than one SPA.
- b) **Fire Precautions.** Specific fire precautionary measures listed in this Appendix shall be applicable during CONTRACTOR's Operations in "Fire Precautionary Period" described. The dates of Fire Precautionary Period may be changed by agreement, if justified by unusual weather or other conditions. Required tools and equipment shall be kept in serviceable condition and immediately available for fire fighting at all times during CONTRACTOR's operations in Fire Precautionary Period.
- c) **Substitute Precautions.** The Forest Service may authorize substitute measures or equipment, or waive specific requirements by written notice, if substitute measures or equipment will afford equal protection or some of the required measures and equipment are unnecessary.
- d) **Emergency Precautions.** The Forest Service may require the necessary shutting down of equipment on portions of CONTRACTOR's Operations, as specified by the emergency fire precautions schedule. Under such conditions, after CONTRACTOR cease(s) active operations, CONTRACTOR shall release for hire by Forest Service, if needed, CONTRACTOR's shutdown equipment for fire standby on the Stewardship Project Area or other areas of CONTRACTOR's Operations and personnel for fire standby or fire patrol, when such personnel and equipment are not needed by CONTRACTOR for other fire fighting or protection from fire. Equipment shall be paid for at fire fighting equipment rates common in the area or at prior agreed rates and, if CONTRACTOR request(s), shall be operated only by personnel approved by the CONTRACTOR. Personnel so hired shall be subject to direction and control by Forest Service and shall be paid by Forest Service at fire fighting rates common in the area or at prior agreed rates.

e) **Fire Precautionary Period and Fire Precautions.** Specific fire precautionary measures are set forth below. Upon request of Forest Service, CONTRACTOR shall permit and provide an individual to assist in periodic testing and inspection of required fire equipment. The CONTRACTOR shall promptly remedy deficiencies found through such inspecting and testing.

1. The following requirements shall apply during the period **April 1 to December 31** and during other such periods as specified by Forest Service.

2. C7.2# - SPECIFIED FIRE PRECAUTIONS. (06/2012)

Partner or a designated Partner's Representative shall certify compliance with specific Timber Sale Contract and California Public Resources Code (CPRC) fire precautionary measures in B7.1 Plans, C7.2# and C7.22#. Certification shall be provided prior to starting operations during Fire Precautionary Period and shall be updated as needed.

Listing of specific fire precautionary measures in the following subsections is not intended to relieve Partner in any way from compliance with State fire laws covering fire prevention and suppression equipment applicable to Partner's Operations.

Upon request of Forest Service, Partner shall permit and assist in periodic testing and inspection of required fire equipment.

The following definitions shall apply to C7.2# and C7.22#:

**Active Landing:** A location Purchaser is skidding logs into, or performing other operations such as delimiting, log manufacturing, and chipping logs. Except for **3** and **4** days, loading logs or stockpiled chips only on a cleared landing does not constitute an Active Landing.

**Hot Saw:** A harvesting system that employs a high-speed (>1100 rpm) rotating felling head (i.e., full rotation lateral tilt head).

**Mechanical Operations:** The process of felling, skidding, chipping, shredding, piling, log processing and/or yarding which requires the use of motorized power which includes, chainsaws, chippers, motorized carriages, masticators, stroke delimiters, skidders, etc.

Specific equipment requirements and fire precautionary measures are shown in the following table and in C7.22#:

A. Fire Tools and Equipment Purchaser shall meet applicable parts of Section 4428 of the CPRC.

Unless agreed otherwise, Fire tools kept at each Active Landing shall be sufficient to equip all employees in the felling, yarding, loading, chipping, and material processing operations associated with each landing. Fire equipment shall include two tractor headlights for each tractor dozer used in Purchaser's Operations. Tractor headlights shall be attachable to each tractor and served by an adequate power source. Fire tools shall

be kept in a sealed fire tool box adjacent to the Active Landing and readily accessible in event of fire.

Where cable yarding is used, Purchaser shall provide a size 0 or larger shovel with an overall length of not less than 46 inches and a serviceable 5-gallon backpack pump filled with water or a fire extinguisher bearing a label showing at least a 4-A rating must be within 25 feet of each tail and corner block.

Trucks, tractors/skidlers, pickups and other similar mobile equipment shall be equipped with and carry at all times a size 0 or larger shovel with an overall length of not less than 46 inches and a 2-1/2 pound axe or larger with an overall length of not less than 28 inches.

All required fire tools shall be maintained in suitable and serviceable condition for firefighting purposes.

B. Fire Extinguishers

Purchaser shall equip each internal combustion yarder, fuel truck, and loader with a (4-A:60-B:C) fire extinguisher for oil and grease fires.

Skidders and tractors shall be equipped with a minimum 5-BC fire extinguisher.

Fire extinguishers shall be mounted, readily accessible, properly maintained and fully charged.

Purchaser shall equip all mechanized harvesting machines and log processors with hydraulic systems, powered by an internal combustion engine (e.g. masticator, chipper, feller/buncher, harvester, forwarder, Hot Saw, stroke delimeter, etc), with at least two 4-A:60-B:C fire extinguishers or an acceptable CAFS substitute identified in Section K.

C. Spark Arresters and Mufflers

Except for tractors and other equipment with exhaust-operated turbochargers, Purchaser shall equip each operating tractor and any other internal combustion engine with an approved spark arrester. There shall be no exhaust bypass on any system.

Spark Arresters shall be a model tested and approved under Forest Service Standard 5100-1a as shown in the National Wildfire Coordinating Group Spark Arrester Guide, Volumes 1 and 2, and shall be properly mounted and maintained according to manufacturer's specifications.

Every motor vehicle subject to registration shall always be equipped with an adequate exhaust system meeting the requirements of the California Vehicle Code.

D. Power Saws

Each power saw shall be equipped with a spark arrester approved and maintained in effective working order as identified in the Spark Arrester Guide in Section C. above and according to applicable parts of CPRC Section 4442 or 4443. An Underwriters Laboratories (UL) approved fire extinguisher containing a minimum 14 ounces of fire retardant shall be kept with each operating saw.

A size 0 or larger shovel with an overall length of not less than 38 inches shall be kept with each gas can, but not more than 300 feet from each power saw when used off cleared landing areas.

E. Fire Supervisor & Fire Patrolperson

Purchaser shall designate in the fire plan required by B7.1 and furnish on Sale Area during operating hours a fire supervisor, named in writing and authorized to act on behalf of Purchaser in fire prevention and suppression matters.

Unless agreed otherwise, Purchaser shall furnish and designate in writing, a Fire Patrolperson each operating day. When on duty, the Fire Patrolperson is required to patrol the operation for the prevention and detection of fires, to take suppression action where necessary and to notify Forest Service as required under Sections I. Reporting Fires and L. Communications. This Fire Patrol is required on foot, unless otherwise agreed.

By written agreement, one Fire Patrolperson may provide patrol on this and adjacent projects or sales. No Fire Patrolperson shall be required on Specified Road construction jobs except during clearing operations unless otherwise specified.

Under Level 1, this requirement may be waived by the Forest Service if justified by existing conditions.

F. Seasonal Permits

Purchaser shall obtain written permits from Forest Service before allowing welding, warming fires or burning, subject to C7.22# - Emergency Precautions.

G. Clearing of Fuels

Welding equipment and stationary log loaders, yarders and other equipment listed in California State Law:	10 feet slope radius
Tail or corner haulback blocks:	All running blocks on a cable yarding operation shall be in the center of an area that is cleared to mineral soil at least 15 feet in diameter.
Lines near, between or above blocks:	Sufficient clearing to prevent line from rubbing on snags, down logs and other dead woody material.

Purchaser shall clear away, and keep clear, fuels and logging debris as follows:

H. Smoking

All smoking shall be confined within a car, truck, crew rig or other enclosed cab after 1:00 PM on 3 days and all hours on 4 days (C7.22#). At other times, any smoking shall be done while

sitting in an area at least 3 feet in diameter, cleared of flammable materials. Burning tobacco and matches shall be extinguished before they are properly disposed.

I. Reporting Fires

As soon as feasible, but no later than **15 minutes** after discovery, Purchaser shall notify Forest Service of any fires on Sale Area or along roads used by Purchaser.

J. Tank Truck

Purchaser shall provide a water tank truck or trailer on or in proximity to Sale Area during Purchaser's Operations hereunder during Fire Precautionary Period unless otherwise agreed.

Tank truck or trailer shall contain at least 300 gallons of water and comply with the following requirements:

(1) Pump, which at sea level, can deliver 23 gallons per minute at 175 pounds per square inch measured at the pump outlet. Pumps shall be tested on Sale Area by Forest Service using a 5/16 inch orifice with a one inch in line test kit and shall meet or exceed the pressure values identified in the following table for nearest temperature and elevation:

Temp	Sea Level		100 Feet	2000 Feet		3000 Feet		4000 Feet		5000 Feet		6000 Feet		7000 Feet		8000 Feet		9000 Feet		10000 Feet		
55	179	23	174	23	169	23	165	22	161	22	157	22	153	22	150	21	146	21	142	21	139	21
70	175	23	171	23	166	22	162	22	158	22	154	22	150	21	147	21	143	21	139	21	136	20
85	171	23	168	23	163	22	159	22	155	22	151	21	147	21	144	21	140	21	136	20	133	20
100	168	23	164	23	159	22	155	22	152	22	148	21	144	21	141	21	137	20	133	20	131	20
	P	G	P	G	P	G	P	G	P	G	P	G	P	G	P	G	P	G	P	G	P	G
	S	P	S	P	S	P	S	P	S	P	S	P	S	P	S	P	S	P	S	P	S	P
	I	M	I	M	I	M	I	M	I	M	I	M	I	M	I	M	I	M	I	M	I	M

The pump outlet shall be equipped with 1-1/2 inch National Standard Fire Hose thread. A bypass or pressure relief valve shall be provided for other than centrifugal pumps.

(2) 300 feet of 3/4-inch inside diameter rubber-covered high-pressure hose mounted on live reel attached to pump with no segments longer than 50 feet, when measured to the extreme ends of the couplings. Hose shall have reusable compression wedge type 1-inch brass or lightweight couplings (aluminum or plastic). One end of hose shall be equipped with a coupling female section and the other end with a coupling male section. The hose shall, with the nozzle closed, be capable of withstanding 200 PSI pump pressure without leaking, distortions, slipping of couplings, or other failures.



(3) A shut-off combination nozzle that meets the following minimum performance standards when measured at 100 P.S.I. at the nozzle:

	G.P.M.	Horizontal Range
Straight Stream	10	38 feet
Fog Spray	6 - 20	N/A

(4) Sufficient fuel to run pump at least 2 hours and necessary service accessories to facilitate efficient operation of the pump.

(5) When Purchaser is using Hot Saws or Masticators an additional 250 feet of light weight hose, approved by Forest Service, shall be immediately available for use and be capable of connecting to the 300 feet of hose and appurtenances in (2) and (3) above.

(6) This equipment and accessories shall be deliverable to a fire in the area of operations and is subject to the requirements for each specific activity level identified in C7.22#.

K. Compressed Air  
Foam System  
(CAFS)

A fire suppression system where compressed air is added to water and a foaming agent. By agreement, Purchaser may substitute a CAFS or functional equivalent in lieu of the tank truck, trailer or fire extinguishers, provided it meets or exceeds the following specifications and requirements:

1. Variable foam expansion ratio - 10:1 to 20:1.
2. Units shall be kept fully charged with air; water and foam concentrate as recommended by the manufacturer and have the appropriate tools to service the system.
3. The unit shall contain enough energy to empty tank and clear hose prior to exhausting propellant.
4. The unit shall be capable of being completely recharged within 10 minutes.
5. When used on cable yarding landings, the unit shall be outfitted for immediate attachment to carriage and transported without damage to the unit.

Fire extinguishers required for Hot Saws, Masticators and similar equipment identified in Section B. above may be substituted with a 3 gallon CAFS.

Tank truck, trailer or equivalent may be substituted with a 30 Gallon CAFS with at least 550 feet of one inch hose and an adjustable nozzle with enough water, air and foam concentrate for at least one recharge.

This equipment and accessories shall also be deliverable to a fire in the area of operations and subject to the requirements for each specific activity level identified in C7.22#.

L. Communications Purchaser shall furnish a serviceable communications system such as a telephone, radio-telephone, radio system or satellite phone connecting each operating side within the Sale Area with Purchaser's headquarters, and capable of notifying Forest Service within **15 minutes** of discovery of any fires on the Sale Area or along Purchaser's haul route. When such headquarters is at a location which makes communication to it clearly impractical, Forest Service may agree to a reasonable alternative notification method.

A Citizen's Band (CB)radio is not acceptable communications.

M. Cable Yarding Tank Unit When all or part of Included Timber will be harvested by a long span (over 1,500 feet) cable yarding operation, Purchaser shall provide at each active cable yarding landing a tank truck, trailer or acceptable CAFS substitute which can be lifted and transported by the carriage.

The unit shall meet the same requirements as specified for the tank truck, trailer or approved CAFS substitute.

N. Helicopter Yarding Fire Precautions Purchaser shall provide and maintain fire equipment as follows:

1. The fire tool box required under this provision shall be equipped for attachment to the helicopter long line so that it may be hauled to needed locations. Such attachment device shall not interfere with access to fire tools. Unless agreed otherwise, the fire tool box shall be located at the Active Landing ready for immediate dispatch.
2. An external helibucket readily attachable to the helicopter, with a capacity of at least 500 gallons, and having a remote-control door mechanism adequate for rapid dropping of water. The helibucket shall be located at the helicopter service landing and shall be filled with water ready for immediate dispatch unless otherwise agreed.
3. All aircraft used in conjunction with Purchaser's Operations shall be equipped with an operable radio system capable of meeting Region Five avionics requirements.
4. For protection of fuel servicing operations, fire extinguishers which have the following ratings based on the open hose discharge capacity, i.e., "broken hose," of the aircraft fueling system shall be readily available:
  - a. Where said capacity does not exceed 200 gallons per minute, at least one approved extinguisher having a minimum rating of 20-B;
  - b. Where said capacity is in excess of 200 gallons per minute, but not over 350 gallons per minute, one approved extinguisher having a minimum rating of 80-B;
  - c. Where said capacity is in excess of 350 gallons per minute, two approved extinguishers, each having a minimum rating of 80-B.

5. By agreement, a suitable CAFS may also be used in lieu of the above extinguishers.
6. Extinguishers of over 50 pounds gross weight shall be of wheeled type or be mounted on carts to provide mobility and ease of handling.

**C7.22# - EMERGENCY PRECAUTIONS.** (xx/xxx) Purchaser/Contractor's Operations shall conform to the limitations or requirements in the Industrial Fire Precaution Activity Level (IFPAL) table below. Unless otherwise agreed in writing, Project Activity Levels applicable to this project shall be the predicted levels for the fire weather station's **41806 for the West & 41310 for the East side of the forest unless otherwise agreed.**

Forest Service, in its sole discretion, may change the predicted activity level if the current fire suppression situation, weather and vegetation conditions warrant an adjustment. If practicable, Forest Service will determine the following day's activity level by 6:00 PM. Purchaser shall obtain the predicted Industrial Fire Precaution Activity Level from the appropriate Ranger District Office before starting work each day or at: [https://publicdashboards.dl.usda.gov/t/NRE\\_PUB/views/ProjectActivityLevelPALandIndustrialFirePrecautionActivityLevelIFPAL-California\\_Web/IFPALDashboard?%3Aembed=y&%3Aiid=8&%3AisGuestRedirectFromVizportal=y](https://publicdashboards.dl.usda.gov/t/NRE_PUB/views/ProjectActivityLevelPALandIndustrialFirePrecautionActivityLevelIFPAL-California_Web/IFPALDashboard?%3Aembed=y&%3Aiid=8&%3AisGuestRedirectFromVizportal=y)

Forest Service may change the Industrial Fire Project Activity Level Table to other values upon revision of the National Fire Danger Rating System. When Purchaser is notified, the revised Industrial Fire Precaution Activity Levels will supersede the levels in the Project Activity Level Table below.

**Purchaser may install a weather recording device in a location and manner agreed to by the Forest Service. Such a device shall be able to record relative humidity and temperature and have the ability to record and store data for at least fourteen days. The device shall have the capability to be accessed by the Forest Service using customarily available wireless technology.**

**INDUSTRIAL FIRE PRECAUTION ACTIVITY LEVEL (IFPAL) - C7.22# - EMERGENCY PRECAUTIONS**

**PROJECT ACTIVITY LEVEL TABLE**

<b>Level</b>	<b>Project Activity Minimum Requirements and Restrictions. Restrictions at each level are cumulative.</b>
<b>1</b>	1. Minimum required by C7.2#. 2. Immediately after Mechanical Operations cease, Fire Patrol is required for one hour.
<b>2</b>	1. Tank truck, trailer, or approved CAFS substitute shall be on or adjacent to the Active Landing. 2. When Hot Saws are operating, a tank truck, trailer or approved CAFS substitute shall be within a 10-minute response time of these operations. Effective communications shall exist between the operator and the Active Landing.

	<p>3. No blasting, mowing, welding, cutting, or grinding of metal between 12:00 PM and 7:00 PM, unless hourly onsite recorded readings show a relative humidity above <b>25</b> percent.</p>
<p><b>3</b></p>	<ol style="list-style-type: none"> <li>1. Immediately after Hot Saw operations cease, Fire patrol is required for two hours.</li> <li>2. No Welding or cutting of metal after 12:00 PM, except by special permit.</li> <li>3. The following activities may operate all day: <ol style="list-style-type: none"> <li>a. Loading and hauling logs decked at approved landings.</li> <li>b. Loading and hauling chips stockpiled at approved landings.</li> <li>c. Servicing equipment at approved sites.</li> <li>d. Dust abatement, road maintenance (Chainsaw use prohibited), culver installation within cleared area, chip sealing, paving, earth moving or rock aggregate stockpile loading and installation (does not include pit or quarry development).</li> <li>e. Chainsaw and log processing operations associated with loading logs or other forest products at approved landings.</li> </ol> </li> <li>4. Hot saws may operate until 12:00 PM; provided that: <ol style="list-style-type: none"> <li>a. A tractor or other equipment with a blade capable of constructing fireline is on or adjacent to the active landing or within ten minutes of the operating equipment. This piece of equipment shall have effective communication with the Hot Saw.</li> <li>b. Any additional restrictions specified by the Forest.</li> </ol> </li> <li>5. Hot saws may operate between 12:00 PM and 7:00 PM, if hourly onsite weather readings indicate a relative humidity above <b>25</b> percent, provided that: <ol style="list-style-type: none"> <li>a. A tractor or other equipment with a blade capable of constructing fireline is on or adjacent to the active landing or within ten minutes of the operating equipment. This piece of equipment shall have effective communication with the Hot Saw.</li> <li>b. Any additional restrictions specified by the Forest.</li> <li>c. Hot Saws shall not operate after 12:00 PM, regardless of relative humidity value, when the National Weather Service issues red flag warning(s), or fire weather watches.</li> </ol> </li> <li>6. All other conventional and Mechanical Operations are permitted until 12:00 PM. Conventional and Mechanical Operations between 12:00 PM and 7:00 PM are prohibited, unless hourly onsite weather readings indicate relative humidity values of <b>25</b> percent or greater. Regardless of relative humidity readings, no operations shall be permitted when the National Weather Service issues red flag warning (s), or fire weather watches.</li> </ol>

	<p>7. When relative humidity is below 25% some operations may be permitted after 12:00 PM, on a case-by-case basis, under the terms of a <i>IFPAL Variance Agreement</i>. Activities for which a <i>Variance</i> may be issued are:</p> <ul style="list-style-type: none"> <li>• Rubber Tire Skidding</li> <li>• Cable Yarding with a non-motorized carriage</li> <li>• Chipping on Landings</li> <li>• Helicopter Yarding</li> <li>• Fire Salvage</li> </ul> <p>When approved by a Line Officer, a Variance Agreement can be implemented when the criteria specified in the agreement are met and mitigation measures are in place. Variance approval can be withdrawn at the sole discretion of Forest Service. Variance approval is contingent on the 7-day fire weather forecast, fuel conditions, site characteristics, current fire situation, state of Purchaser's equipment for prevention and suppression readiness, type of operation and social and community considerations etc. (See attached Project Activity Level Variance Agreement).</p>
4	<p>The following activities may operate all day:</p> <ol style="list-style-type: none"> <li>1. Loading and hauling logs decked at approved landings.</li> <li>2. Loading and hauling chips stockpiled at approved landings.</li> <li>3. Servicing Equipment at approved sites.</li> <li>4. Dust abatement, road maintenance (chainsaw use prohibited) or loading stockpiles and rock aggregate installation (does not include pit or quarry development).</li> <li>5. Chainsaw operation associated with loading at approved landings.</li> </ol> <p>All other activities are prohibited.</p>

47. **Fire Control.** The CONTRACTOR shall, both independently and in cooperation with Forest Service, take all reasonable and practicable action to prevent and suppress fires resulting from CONTRACTOR's Operations and to suppress any forest fire on Stewardship Project Area. The CONTRACTOR's independent initial fire suppression action on such fires shall be immediate and shall include the use of all necessary personnel and equipment at CONTRACTOR's disposal on Stewardship Project Area or within the distance of Stewardship Project Area: (fill-in miles).

a) **The Partner's Reinforcement Obligations.** Whenever an Operations Fire or Negligent Fire, whether on or off Stewardship Project Area or any other forest fire on Stewardship Project Area, has not been suppressed by initial action and appreciable reinforcement strength is required, Forest Service may require further actions by CONTRACTOR until such fire is controlled and mopped up to a point of safety. Such actions may include any or all of the following as necessary to fight such fire:

b) **Suspend Operations.** To suspend any or all of CONTRACTOR's Operations.

- c) **Personnel.** To release for employment by Forest Service any or all of CONTRACTOR's personnel engaged in CONTRACTOR's Operations or timber processing within the distance of Stewardship Project Area: (*fill-in miles*). Any organized crew so hired shall include CONTRACTOR's supervisor, if any. Personnel so employed shall be paid at Forest Service standard emergency fire fighting rates.
- d) **Equipment.** To make available for Forest Service rental at fire fighting equipment rates common in the area or at prior agreed rates any or all of CONTRACTOR's equipment suitable for fire fighting and currently engaged in CONTRACTOR's Operations within the distance of Stewardship Project Area: (*fill-in miles*). Equipment shall be operated only by personnel approved by CONTRACTOR, if so requested by CONTRACTOR.

48. **Temporary Roads and Skid Trails.** The CONTRACTOR shall locate Temporary Roads and Skid Trails on locations approved by the Forest Service. Such location shall include the marking of road centerline or grade-line and the setting of such construction stakes as are necessary to provide a suitable basis for economical construction and the protection of National Forest lands.

Temporary road surface width shall be limited to truck bunk width plus four (4) feet, except for needed turnouts which shall not exceed two (2) times the bunk width plus four (4) feet. If shovels or cranes with revolving carriage are used to skid or load, temporary road surface width equal to track width plus tail swing shall be permitted.

As necessary to attain stabilization of roadbed and fill slopes of Temporary Roads, CONTRACTOR shall employ such measures as outsloping, drainage dips, and water-spreading ditches.

**APPENDIX H**  
**FIRE PLAN FOR CONSTRUCTION AND SERVICE CONTRACTS**  
**03/06/2013**

1. **SCOPE:**

The provisions set forth below outline the responsibility for fire prevention and suppression activities and establish a suppression plan for fires within the contract area. The contract area is delineated by map in the contract. The provisions set forth below also specify conditions under which contract activities will be curtailed or shut down.

2. **RESPONSIBILITIES:**

A. Contractor

- (1) Shall abide by the requirements of this Fire Plan.
- (2) Shall take all steps necessary to prevent his/her employees, subcontractors and their employees from setting fires not required in completion of the contract, shall be responsible for preventing the escape of fires set directly or indirectly as a result of contract operations, and shall extinguish all such fires which may escape.
- (3) Shall permit and assist in periodic testing and inspection of required fire equipment. Contractor shall certify compliance with specific fire precautionary measures in the fire plan, before beginning operations during Fire Precautionary Period and shall update such certification when operations change.
- (4) Shall designate in the Fire Plan and furnish on Contract Area, during operating hours, a qualified fire supervisor authorized to act on behalf of Contractor in fire prevention and suppression matters.

B. Forest Service

The Forest Service may conduct one or more inspections for compliance with the Fire Plan. The number, timing, and scope of such inspections will be at the discretion of agency employees responsible for contract administration. Such inspections do not relieve the Contractor of responsibility for correcting violations of the fire plan or for fire safety in general, as outlined in paragraph 2.A above.

3. **DEFINITIONS:**

The following definitions shall apply:

**Active Landing:** A location the contractor may be skidding logs into, or performing other operations such as de-limbing, log manufacturing, and chipping logs. Except for EV and E days, loading logs or stockpiling chips only, on a cleared landing, does not constitute an Active Landing.

**Hot Saw:** A harvesting system that employs a high-speed (>1100 rpm) rotating felling head, i.e., full rotation lateral tilt head.

**Mechanical Operations:** The process of felling, skidding, chipping, shredding, masticating, piling, log processing and/or yarding which requires the use of motorized power which includes, chainsaws, chippers, motorized carriages, masticators, stroke de-limbers, skidders, dozers etc.

4. **TOOLS AND EQUIPMENT:**

The Contractor shall comply with the following requirements during the fire precautionary period, as defined by unit administering contracts:

**The Fire Precautionary Period is set by the State of California which is April 1 through December 1 of any year.**

- This contract  requires,  does not require, a Fire Box and associated Fire Tools according to CPRC Section 4428.

**A. Fire Tools and Equipment:** Contractor shall meet minimum requirements of Section 4428 of the California Public Resources Code (C.P.R.C.). Fire tools kept at each operating landing shall be sufficient to equip all employees in the felling, yarding, loading, chipping, and material processing operations associated with each landing. Fire equipment shall include two tractor headlights for each tractor dozer used in Contractor's Operations. Tractor headlights shall be attachable to each tractor and served by an adequate power source. All required fire tools shall be maintained in suitable and serviceable condition for fire fighting purposes.

Trucks, tractors, skidders, pickups and other similar mobile equipment shall be equipped with and carry at all times a size 0 or larger shovel with an overall length of not less than 46 inches and a 2-1/2 pound axe or larger with an overall length of not less than 28 inches.

Where cable yarding is used, Contractor shall provide a size 0 or larger shovel with an overall length of not less than 46 inches and a filled backpack can (4 or 5 gallon) with hand pump within 25 feet of each tail and corner block.

**B. Fire Extinguishers:** Contractor shall equip each internal combustion yarder, fuel truck, and loader with a fire extinguisher for oil and grease fires (4-A:60-B:C).

Skidders and tractors shall be equipped with a minimum 5-BC fire extinguisher.

All Fire Extinguishers shall be mounted, readily accessible, properly maintained and fully charged.

Contractor shall equip each mechanized harvesting machine with hydraulic systems, powered by an internal combustion engine (chipper, feller/buncher, harvester, forwarder, hot saws, stroke de-limber, etc.), except tractors and skidders, with at least two 4-A:60-B:C fire extinguishers or equivalent.

**C. Spark Arresters and Mufflers:** Contractor shall equip each operating tractor and any other internal combustion engine with a spark arrester, except for motor vehicles equipped with a maintained muffler as defined in C.P.R.C. Section 4442 or tractors with exhaust-operated turbochargers. Spark Arresters shall be a model tested and approved under Forest Service Standard 5100-1a as shown in the National Wildlife Coordinating Group Spark Arrester Guide, Volumes 1 and 2, and shall be maintained in good operating condition. Every motor vehicle subject to registration shall at all times be equipped with an adequate exhaust system meeting the requirements of the California Vehicle Code.

**D. Power Saws:** Each power saw shall be equipped with a spark arrester approved according to C.P.R.C. Section 4442 or 4443 and shall be maintained in effective working order. An Underwriters Laboratories (UL) approved fire extinguisher containing a minimum 14 ounces of fire retardant shall be kept with each operating power saw. In addition, a size 0 or larger shovel with an overall length of not less than 38 inches shall be kept with each gas can but not more than 300 feet from each power saw when used off cleared landing areas.

- This contract  requires,  does not require, Section 4E of the Fire Plan.

**E. Tank Truck or Trailer:** Contractor shall provide a water tank truck or trailer on or in proximity to Contract Area during Contractor's Operations hereunder during Fire Precautionary Period. When Project Activity Level C or higher is in effect, a tank truck or trailer shall be on or immediately adjacent to each active landing, unless otherwise excepted when Hot Saws or Masticators are being used. See Section 6 for specific contract requirements.

The tank shall contain at least 300 gallons of water available for fire suppression. Ample power and hitch shall be readily available for promptly and safely moving tank over roads serving Contract Area. Tank truck or trailer shall be equipped with the following:

- (1) Pump, which at sea level, can deliver 23 gallons per minute at 175 pounds per square inch measured at the pump outlet. Pumps shall be tested on Contract Area using a 5/16-inch orifice in the Forester One Inch In-Line Gauge test kit. Pump shall meet or exceed the pressure value in the following table for nearest temperature and elevation:



T e m p	Sea Level		1000 Feet		2000 Feet		3000 Feet		4000 Feet		5000 Feet		6000 Feet		7000 Feet		8000 Feet		9000 Feet		10000 Feet	
55	179	23	174	23	169	23	165	22	161	22	157	22	153	22	150	21	146	21	142	21	139	21
70	175	23	171	23	166	22	162	22	158	22	154	22	150	21	147	21	143	21	139	21	136	20
85	171	23	168	23	163	22	159	22	155	22	151	21	147	21	144	21	140	21	136	20	133	20
100	168	23	164	23	159	22	155	22	152	22	148	21	144	21	141	21	137	20	133	20	131	20
	P	G	P	G	P	G	P	G	P	G	P	G	P	G	P	G	P	G	P	G	P	G
	S	P	S	P	S	P	S	P	S	P	S	P	S	P	S	P	S	P	S	P	S	P
	I	M	I	M	I	M	I	M	I	M	I	M	I	M	I	M	I	M	I	M	I	M

The pump outlet shall be equipped with 1-1/2-inch National Standard Fire Hose thread. A bypass or pressure relief valve shall be provided for other than centrifugal pumps.

- (2) 300 feet of 3/4-inch inside diameter rubber-covered high-pressure hose mounted on live reel attached to pump with no segments longer than approximately 50 feet, when measured to the extreme ends of the couplings. Hose shall have reusable compression wedge type 1-inch brass or lightweight couplings (aluminum or plastic). One end of hose shall be equipped with a coupling female section and the other end with a coupling male section. The hose shall, with the nozzle closed, be capable of withstanding 200 PSI pump pressure without leaking, distortions, slipping of couplings, or other failures.
- (3) A shut-off combination nozzle that meets the following minimum performance standards when measured at 100 P.S.I. at the nozzle:

	G.P.M.	Horizontal Range
Straight Stream	10	38 feet
Fog Spray	6 - 20	N/A

- (4) Sufficient fuel to run the pump at least 2 hours and necessary service accessories to facilitate efficient operation of the pump.

When Contractor is using Hot Saws or Masticators, an additional 250 feet of light weight hose, approved by the Forest Service, shall be immediately available for use and be capable of connecting to the 300 feet of hose and appurturances in (2) and (3) above.

**This equipment and accessories shall be deliverable to a fire in the area of operations and is subject to the requirements for each specific activity level identified in Section 6.**

**F. Compressed Air Foam System:** A Compressed Air Foam System (CAFS) is a fire suppression system where compressed air is added to water and a foaming agent. By agreement, Contractor may substitute a CAFS or functional equivalent in lieu of the tank truck, trailer or fire extinguishers, provided it meets or exceeds the following specifications and requirements:

1. Variable foam expansion ratio – 10:1 to 20:1.
2. Units shall be kept fully charged with air; water and foam concentrate as recommended by the manufacturer and have the appropriate tools to service the system.
3. The unit shall contain enough energy to empty tank and clear hose prior to exhausting propellant.
4. The unit shall be capable of being completely recharged within 10 minutes.
5. When used on cable yarding landings, the unit shall be outfitted for immediate attachment to carriage and transported without damage to the unit.

Fire extinguishers required for Hot Saws, Masticators and similar equipment identified in Section 4 B. above may be substituted with a 3-gallon CAFS.

Tank truck, trailer or equivalent may be substituted with a 30 Gallon CAFS with at least 550 feet of one-inch hose and an adjustable nozzle with enough water, air and foam concentrate for at least one recharge.

**This equipment and accessories shall also be deliverable to a fire in the area of operations and subject to the requirements for each specific activity level identified in Section 6.**

5. **GENERAL**

- A. **State Law:** In addition to the requirements in this Fire Plan, the Contractor shall comply with all applicable laws of the State of California. In particular, see California Public Resource Codes.
- B. **Permits Required:** The Contractor must secure a special written permit from the District Ranger or designated representative before burning, welding or cutting metal or starting any warming fires. If contract requires Blasting and Storing of Explosives and Detonators, an Explosives Permit may be required pursuant to the California Health and Safety Code, Section 12101.
- C. **Blasting:** Contractor shall use electric caps only unless otherwise agreed in writing. When blasting is necessary in slash areas, a Fire Patrolperson equipped with a size 0 or larger shovel with an overall length of not less than 46 inches and a filled backpack can (4 or 5 gallon) with hand pump shall remain in the immediate area for an hour after blasting has been completed.
- D. **Smoking:** Smoking shall not be permitted during fire season, except in a barren area or in an area cleared to mineral soil at least three feet in diameter. In areas closed to smoking, the CO may approve special areas to be used for smoking. The Contractor shall sign designated smoking areas. Contractor shall post signs regarding smoking and fire rules in conspicuous places for all employees to see. Contractor's supervisory personnel shall require compliance with these rules. Under no circumstances shall smoking be permitted during fire season while employees are operating light or heavy equipment, walking, or working in grass and woodlands.
- E. **Storage and Parking Areas.** Equipment service areas, parking areas, and gas and oil storage areas shall be cleared of all flammable material for a radius of at least 10 feet unless otherwise specified by local administrative unit. Small mobile or stationary internal combustion engine sites shall be cleared of flammable material for a slope distance of at least 10 feet from such engine. The COR shall approve such sites in writing.
- F. **Reporting Fires:** As soon as feasible but no later than 15 minutes after initial discovery, Contractor shall notify Forest Service of any fires on Contract Area or along roads used by Contractor. Contractor's employees shall report all fires as soon as possible to any of the following Forest Service facilities and/or personnel listed below, but not necessarily in the order shown:

	Name	Office Address	Office telephone
<b>Dispatch Center</b>	<b>Grass Valley</b>	<b>13120 Loma Rica Road, Grass Valley, CA 95945</b>	<b>(530)478-6111</b>
Nearest FS Station	Tahoe Supervisor's Officer	631 Coyote Street Nevada City, CA 95959	(530)265-4371
Inspector(s)	Chris Pennington	631 Coyote Street Nevada City, CA 95959	(530)478-6830
COR	Rita Clipperton	631 Coyote Street Nevada City, CA 95959	(530)587-3558
District Ranger	Thomas Parrack	631 Coyote Street Nevada City, CA 95959	(530)478-6242 (530)288-3231

**When reporting a fire, provide the following information:**

- Your Name
- Call back telephone number
- Project Name
- Location: Legal description (Township, Range, Section); and Descriptive location (Reference point)
- Fire Information: Including Acres, Rate of Spread and Wind Conditions.

▪ **This contract  requires,  does not require, Section 5G of the Fire Plan.**

G. **Communications:** Contractor shall furnish a serviceable telephone, radio-telephone or radio system connecting each operating side with Contractor's headquarters. When such headquarters is at a location which makes communication to it clearly impractical, Forest Service may accept a reasonable alternative location. The communication system shall provide prompt and reliable communications between Contractor's headquarters (or agreed to alternative) and Forest Service via commercial or Forest Service telephone.

▪ **This contract  requires,  does not require, Section 5H of the Fire Plan.**

H. **Fire Patrol Personnel:** Contractor shall furnish a qualified fire patrol person each operating day when Project Activity Level C or higher is in effect. The patrol person will observe and patrol project area for a certain duration of time as all project work concludes at the end of each workday, the COR will evaluate and provide the required timeframe to the contractor. When on duty, sole responsibility of patrol person shall be to patrol the operation for prevention and detection of fires, take suppression action where necessary and notify the Forest Service as required. This Fire patrol is required on foot, unless otherwise agreed. By agreement, one patrol person may provide patrol on this and adjacent projects. No patrol person shall be required on Specified Road construction jobs except during clearing operations unless otherwise specified.

The Contractor shall, prior to commencing work, furnish the following information relating to key personnel:

<u>Title</u>	<u>Name</u>	<u>Telephone Number</u>
<u>Fire Supervisor</u>		
<u>Fire Patrol Personnel</u>		

I. **Clearing of Fuels:** Contractor shall clear away, and keep clear, fuels and logging debris as follows:

Welding equipment and stationary log loaders, yarders and other equipment listed in California State Law:	10 feet slope radius
Tail or corner haul back blocks:	All running blocks shall be located in the center of an area cleared to mineral soil at least 15 feet in diameter.
Lines near, between or above blocks:	Sufficient clearing to prevent line from rubbing on snags, down logs and other dead woody material.

6. **EMERGENCY PRECAUTIONS**

Contractor's Operations shall conform to the limitations or requirements in the Project Activity Level (PAL) table below. Project Activity Levels applicable to this project shall be the predicted activity levels for the Fire Danger Rating Area(s), or fire weather station(s) stated in the Contract Area Map Legend on Integrated Resource Service Contracts (IRSC's), and other contracts where applicable.

**Fire Danger Rating Area/Fire Weather Station for Project**

Whitecloud

---

The Forest Service, in its sole discretion, may change the predicted activity level if the current fire suppression situation, weather and vegetation conditions warrant an adjustment. If practicable, Forest Service will determine the following day's activity level by 6:00 PM. Contractor shall obtain the predicted Project Activity Level from the appropriate Ranger District Office before starting work each day.

**Phone Number or Website to obtain Predicted Activity Levels:**

530-478-6176

---

Forest Service may change the Project Activity Level Table to other values upon revision of the National Fire Danger Rating System. When Contractor is notified, the revised Project Activity Levels will supersede the levels in the Project Activity Level Table below.

## PROJECT ACTIVITY LEVEL

<i>Level</i>	<i>Project Activity Minimum Requirements and Restrictions. Restrictions at each level are cumulative.</i>
<b>A</b>	Minimum requirements noted above in Sections 4 and 5.
<b>B</b>	1. Tank truck, trailer, or approved CAFS substitute shall be on or adjacent to the Active Landing.
<b>C</b>	1. When Hot Saws or Masticators are operating, a tank truck, trailer, or approved CAFS substitute shall be within ¼ mile of these operations. Effective communications shall exist between the operator and the Active Landing. 2. Immediately after Mechanical Operations cease, Fire patrol is required for two hours.
<b>D</b>	1. Immediately after Hot Saw or Masticator operations cease, Fire patrol is required for three hours. 2. No Dead Tree felling after 1:00 PM, except recently dead. 3. No burning, blasting, welding or cutting of metal after 1:00 PM, except by special permit.
<b>Ev</b>	<p>1. The following activities may operate all day:</p> <ul style="list-style-type: none"> <li>a) Loading and hauling logs decked at approved landings.</li> <li>b) Loading and hauling chips stockpiled at approved landings.</li> <li>c) Servicing equipment at approved sites.</li> <li>d) Dust abatement, road maintenance (Chainsaw use prohibited), culvert installation within cleared area, chip sealing, paving, earth moving or rock aggregate stock pile loading and installation (does not include pit or quarry development).</li> <li>e) Chainsaw and log processing operations associated with loading logs or other forest products at approved landings.</li> </ul> <p>2. Hot Saws or Masticators may operate until 1:00 PM; provided that:</p> <ul style="list-style-type: none"> <li>a) A tractor with a blade or other equipment capable of constructing fireline is on or adjacent to the active landing or within ¼ mile of the operating equipment. This piece of equipment shall have effective communication with the Hot Saw or Masticator.</li> <li>b) Any additional restrictions specified by the Forest.</li> </ul> <p>3. All other conventional Mechanical Operations are permitted until 1:00 PM.</p> <p>4. Some operations may be permitted after 1:00 PM, on a case-by-case basis, under the terms of a PAL Ev Variance Agreement. Activities for which a Variance may be issued are:</p> <ul style="list-style-type: none"> <li>• Rubber Tire Skidding</li> <li>• Chipping on Landings</li> <li>• Helicopter Yarding</li> <li>• Fire Salvage</li> </ul> <p>When approved by a Line Officer, a Variance Agreement can be implemented when the criteria specified in the agreement are met and mitigation measures are in place. This approval is good for ten (10) days unless cancelled sooner or extended by the Contracting Officer for an additional ten (10) days. Variance approval can be withdrawn at the sole discretion of the Forest Service. Variance approval is contingent on the 7-day fire weather forecast, fuel conditions, site characteristics, current fire situation, state of Contractor's equipment for prevention and suppression readiness, type of operation and social and community considerations etc. (See attached Project Activity Level Variance Agreement).</p>
<b>E</b>	<p>The following activities may operate all day:</p> <ul style="list-style-type: none"> <li>1. Loading and hauling logs decked at approved landings.</li> <li>2. Loading and hauling chips stockpiled at approved landings.</li> <li>3. Servicing Equipment at approved sites.</li> <li>4. Dust abatement, road maintenance (chainsaw use prohibited) or loading stockpiles and rock aggregate installation (does not include pit or quarry development).</li> <li>5. Chainsaw operation associated with loading at approved landings.</li> </ul> <p>All other activities are prohibited.</p>

This Project utilizes “The Project Activity Level” (PAL), an industrial operation’s fire precaution system. The following Climatology Chart indicates the average estimated Activity Levels in 2024 reported from the TNF Westside PAL Dispatch line. This is only for the 2024 season, as recent data prior to 2024 is unavailable.

Project Activity Level Climatology								
Fire Danger Rating Area/Weather Station:		TNF Westside PAL dispatch			Years Analyzed		2024	
	A	B	C	D	Ev	E	Days	
Month	Average Estimated Days per Month at Each PAL Value						Days	Analyzed
July	0	3	0	6	5	17	31	
August	4	3	5	5	9	5	31	
September	7	5	3	2	9	4	30	
October								

I have considered the above request and determined specific mitigation measures or actions must be implemented to operate. Unless extended, the approval remains in effect for thirty (30) calendar days. At the sole discretion of the Forest Service, this plan can be modified and/or cancelled at no cost to the government.

\_\_\_\_\_  
Fire Management Officer Concurrence \_\_\_\_\_  
Date

\_\_\_\_\_  
Line Officer Approval \_\_\_\_\_  
Date

\_\_\_\_\_  
Contracting Officer \_\_\_\_\_  
Date

\_\_\_\_\_  
Contractor Representative \_\_\_\_\_  
Date

C7.2# - SPECIFIED FIRE PRECAUTIONS. (xx/xxx)

Purchaser or a designated Purchaser's Representative shall certify compliance with specific Timber Sale Contract and California Public Resources Code (CPRC) fire precautionary measures in B7.1 Plans, C7.2# and C7.22#. Certification shall be provided prior to starting operations during Fire Precautionary Period and shall be updated as needed.

Listing of specific fire precautionary measures in the following subsections is not intended to relieve Purchaser in any way from compliance with State fire laws covering fire prevention and suppression equipment applicable to Purchaser's Operations.

Upon request of Forest Service, Purchaser shall permit and assist in periodic testing and inspection of required fire equipment.

The following definitions shall apply to C7.2# and C7.22#:

**Active Landing:** A location Purchaser is skidding logs into, or performing other operations such as delimiting, log manufacturing, and chipping logs. Except for 3 and 4 days, loading logs or stockpiled chips only on a cleared landing does not constitute an Active Landing.

**Hot Saw:** A harvesting system that employs a high-speed (>1100 rpm) rotating felling head (i.e., full rotation lateral tilt head).

**Mechanical Operations:** The process of felling, skidding, chipping, shredding, piling, log processing and/or yarding which requires the use of motorized power which includes, chainsaws, chippers, motorized carriages, masticators, stroke delimiters, skidders, etc.

Specific equipment requirements and fire precautionary measures are shown in the following table and in C7.22#:

A. Fire Tools and Equipment Purchaser shall meet applicable parts of Section 4428 of the CPRC.

Unless agreed otherwise, Fire tools kept at each Active Landing shall be sufficient to equip all employees in the felling, yarding, loading, chipping, and material processing operations associated with each landing. Fire equipment shall include two tractor headlights for each tractor dozer used in Purchaser's Operations. Tractor headlights shall be attachable to each tractor and served by an adequate power source. Fire tools shall be kept in a sealed fire tool box adjacent to the Active Landing and readily accessible in event of fire.

Where cable yarding is used, Purchaser shall provide a size 0 or larger shovel with an overall length of not less than 46 inches and a serviceable 5-gallon backpack pump filled with water or a fire extinguisher bearing a label showing at least a 4-A rating must be within 25 feet of each tail and corner block.

Trucks, tractors/skidlers, pickups and other similar mobile equipment shall be equipped with and carry at all times a size 0 or larger shovel with an overall length of not less than 46

inches and a 2-1/2 pound axe or larger with an overall length of not less than 28 inches.

All required fire tools shall be maintained in suitable and serviceable condition for firefighting purposes.

B. Fire Extinguishers

Purchaser shall equip each internal combustion yarder, fuel truck, and loader with a (4-A:60-B:C) fire extinguisher for oil and grease fires.

Skidders and tractors shall be equipped with a minimum 5-BC fire extinguisher.

Fire extinguishers shall be mounted, readily accessible, properly maintained and fully charged.

Purchaser shall equip all mechanized harvesting machines and log processors with hydraulic systems, powered by an internal combustion engine (e.g. masticator, chipper, feller/buncher, harvester, forwarder, Hot Saw, stroke delimeter, etc), with at least two 4-A:60-B:C fire extinguishers or an acceptable CAFS substitute identified in Section K.

C. Spark Arresters and Mufflers

Except for tractors and other equipment with exhaust-operated turbochargers, Purchaser shall equip each operating tractor and any other internal combustion engine with an approved spark arrester. There shall be no exhaust bypass on any system.

Spark Arresters shall be a model tested and approved under Forest Service Standard 5100-1a as shown in the National Wildfire Coordinating Group Spark Arrester Guide, Volumes 1 and 2, and shall be properly mounted and maintained according to manufacturer's specifications.

Every motor vehicle subject to registration shall always be equipped with an adequate exhaust system meeting the requirements of the California Vehicle Code.

D. Power Saws

Each power saw shall be equipped with a spark arrester approved and maintained in effective working order as identified in the Spark Arrester Guide in Section C. above and according to applicable parts of CPRC Section 4442 or 4443. An Underwriters Laboratories (UL) approved fire extinguisher containing a minimum 14 ounces of fire retardant shall be kept with each operating saw.

A size 0 or larger shovel with an overall length of not less than 38 inches shall be kept with each gas can, but not more than 300 feet from each power saw when used off cleared landing areas.

E. Fire Supervisor & Fire Patrolperson

Purchaser shall designate in the fire plan required by B7.1 and furnish on Sale Area during operating hours a fire supervisor, named in writing and authorized to act on behalf of Purchaser in fire prevention and suppression matters.



Unless agreed otherwise, Purchaser shall furnish and designate in writing, a Fire Patrolperson each operating day. When on duty, the Fire Patrolperson is required to patrol the operation for the prevention and detection of fires, to take suppression action where necessary and to notify Forest Service as required under Sections I. Reporting Fires and L. Communications. This Fire Patrol is required on foot, unless otherwise agreed.

By written agreement, one Fire Patrolperson may provide patrol on this and adjacent projects or sales. No Fire Patrolperson shall be required on Specified Road construction jobs except during clearing operations unless otherwise specified.

Under Level 1, this requirement may be waived by the Forest Service if justified by existing conditions.

F. Seasonal Permits

Purchaser shall obtain written permits from Forest Service before allowing welding, warming fires or burning, subject to C7.22# - Emergency Precautions.

G. Clearing of Fuels

Purchaser shall clear away, and keep clear, fuels and logging debris as follows:

Welding equipment and stationary log loaders, yarders and other equipment listed in California State Law:	10 feet slope radius
Tail or corner haulback blocks:	All running blocks on a cable yarding operation shall be in the center of an area that is cleared to mineral soil at least 15 feet in diameter.
Lines near, between or above blocks:	Sufficient clearing to prevent line from rubbing on snags, down logs and other dead woody material.

H. Smoking

All smoking shall be confined within a car, truck, crew rig or other enclosed cab after 1:00 PM on **3** days and all hours on **4** days (C7.22#). At other times, any smoking shall be done while sitting in an area at least 3 feet in diameter, cleared of flammable materials. Burning tobacco and matches shall be extinguished before they are properly disposed.

I. Reporting Fires

As soon as feasible, but no later than **15 minutes** after discovery, Purchaser shall notify Forest Service of any fires on Sale Area or along roads used by Purchaser.

J. Tank Truck

Purchaser shall provide a water tank truck or trailer on or in proximity to Sale Area during Purchaser's Operations hereunder during Fire Precautionary Period unless otherwise agreed.

Tank truck or trailer shall contain at least 300 gallons of water and comply with the following requirements:

(1) Pump, which at sea level, can deliver 23 gallons per minute at 175 pounds per square inch measured at the pump outlet. Pumps shall be tested on Sale Area by Forest Service using a 5/16 inch orifice with a one inch in line test kit and shall meet or exceed the pressure values identified in the following table for nearest temperature and elevation:

T e m p	Sea Level		1000 Feet		2000 Feet		3000 Feet		4000 Feet		5000 Feet		6000 Feet		7000 Feet		8000 Feet		9000 Feet		10000 Feet	
	P	G	P	G	P	G	P	G	P	G	P	G	P	G	P	G	P	G	P	G	P	G
55	179	23	174	23	169	23	165	22	161	22	157	22	153	22	150	21	146	21	142	21	139	21
70	175	23	171	23	166	22	162	22	158	22	154	22	150	21	147	21	143	21	139	21	136	20
85	171	23	168	23	163	22	159	22	155	22	151	21	147	21	144	21	140	21	136	20	133	20
100	168	23	164	23	159	22	155	22	152	22	148	21	144	21	141	21	137	20	133	20	131	20
	P	G	P	G	P	G	P	G	P	G	P	G	P	G	P	G	P	G	P	G	P	G
	S	P	S	P	S	P	S	P	S	P	S	P	S	P	S	P	S	P	S	P	S	P
	I	M	I	M	I	M	I	M	I	M	I	M	I	M	I	M	I	M	I	M	I	M

The pump outlet shall be equipped with 1-1/2 inch National Standard Fire Hose thread. A bypass or pressure relief valve shall be provided for other than centrifugal pumps.

(2) 300 feet of 3/4-inch inside diameter rubber-covered high-pressure hose mounted on live reel attached to pump with no segments longer than 50 feet, when measured to the extreme ends of the couplings. Hose shall have reusable compression wedge type 1-inch brass or lightweight couplings (aluminum or plastic). One end of hose shall be equipped with a coupling female section and the other end with a coupling male section. The hose shall, with the nozzle closed, be capable of withstanding 200 PSI pump pressure without leaking, distortions, slipping of couplings, or other failures.

(3) A shut-off combination nozzle that meets the following minimum performance standards when measured at 100 P.S.I. at the nozzle:

	G.P.M.	Horizontal Range
Straight Stream	10	38 feet
Fog Spray	6 - 20	N/A

(4) Sufficient fuel to run pump at least 2 hours and necessary service accessories to facilitate efficient operation of the pump.

(5) When Purchaser is using Hot Saws or Masticators an additional 250 feet of light weight hose, approved by Forest Service, shall be immediately available for use and be capable of connecting to the 300 feet of hose and appurtenances in (2) and (3) above.

(6) This equipment and accessories shall be deliverable to a fire in the area of operations and is subject to the requirements for each specific activity level identified in C7.22#.

K. Compressed Air  
Foam System  
(CAFS)

A fire suppression system where compressed air is added to water and a foaming agent. By agreement, Purchaser may substitute a CAFS or functional equivalent in lieu of the tank truck, trailer or fire extinguishers, provided it meets or exceeds the following specifications and requirements:

1. Variable foam expansion ratio - 10:1 to 20:1.
2. Units shall be kept fully charged with air; water and foam concentrate as recommended by the manufacturer and have the appropriate tools to service the system.
3. The unit shall contain enough energy to empty tank and clear hose prior to exhausting propellant.
4. The unit shall be capable of being completely recharged within 10 minutes.
5. When used on cable yarding landings, the unit shall be outfitted for immediate attachment to carriage and transported without damage to the unit.

Fire extinguishers required for Hot Saws, Masticators and similar equipment identified in Section B. above may be substituted with a 3 gallon CAFS.

Tank truck, trailer or equivalent may be substituted with a 30 Gallon CAFS with at least 550 feet of one inch hose and an adjustable nozzle with enough water, air and foam concentrate for at least one recharge.

This equipment and accessories shall also be deliverable to a fire in the area of operations and subject to the requirements for each specific activity level identified in C7.22#.

L. Communications

Purchaser shall furnish a serviceable communications system such as a telephone, radio-telephone, radio system or satellite phone connecting each operating side within the Sale Area with Purchaser's headquarters, and capable of notifying Forest Service within **15 minutes** of discovery of any fires on the Sale Area or along Purchaser's haul route. When such headquarters is at a location which makes communication to it clearly impractical, Forest Service may agree to a reasonable alternative notification method.

A Citizen's Band (CB)radio is not acceptable communications.

M. Cable Yarding  
Tank Unit

When all or part of Included Timber will be harvested by a long span (over 1,500 feet) cable yarding operation, Purchaser shall provide at each active cable yarding landing a tank truck, trailer or acceptable CAFS substitute which can be lifted and transported by the carriage.

The unit shall meet the same requirements as specified for the tank truck, trailer or approved CAFS substitute.

N. Helicopter  
Yarding Fire  
Precautions

Purchaser shall provide and maintain fire equipment as follows:

1. The fire tool box required under this provision shall be equipped for attachment to the helicopter long line so that it may be hauled to needed locations. Such attachment device shall not interfere with access to fire tools. Unless agreed otherwise, the fire tool box shall be located at the Active Landing ready for immediate dispatch.
2. An external helibucket readily attachable to the helicopter, with a capacity of at least 500 gallons, and having a remote-control door mechanism adequate for rapid dropping of water. The helibucket shall be located at the helicopter service landing and shall be filled with water ready for immediate dispatch unless otherwise agreed.
3. All aircraft used in conjunction with Purchaser's Operations shall be equipped with an operable radio system capable of meeting Region Five avionics requirements.
4. For protection of fuel servicing operations, fire extinguishers which have the following ratings based on the open hose discharge capacity, i.e., "broken hose," of the aircraft fueling system shall be readily available:
  - a. Where said capacity does not exceed 200 gallons per minute, at least one approved extinguisher having a minimum rating of 20-B;
  - b. Where said capacity is in excess of 200 gallons per minute, but not over 350 gallons per minute, one approved extinguisher having a minimum rating of 80-B;
  - c. Where said capacity is in excess of 350 gallons per minute, two approved extinguishers, each having a minimum rating of 80-B.
5. By agreement, a suitable CAFS may also be used in lieu of the above extinguishers.
6. Extinguishers of over 50 pounds gross weight shall be of wheeled type or be mounted on carts to provide mobility and ease of handling.

---

***Required in all new contracts and contracts to be extended. Contract may also be modified and this provision along with companion provision C7.22# included at Purchaser's request.***

**R5-C7.22#**

C7.22# - **EMERGENCY PRECAUTIONS.** (xx/xxx) Purchaser/Contractor's Operations shall conform to the limitations or requirements in the Industrial Fire Precaution Activity Level (IFPAL) table below. Unless otherwise agreed in writing, Project Activity Levels applicable to this project shall be the predicted levels for the fire weather station's **41806 for the West & 41310 for the East side of the forest unless otherwise agreed.**

Forest Service, in its sole discretion, may change the predicted activity level if the current fire suppression situation, weather and vegetation conditions warrant an adjustment. If practicable, Forest Service will determine the following day's activity level by 6:00 PM. Purchaser shall obtain the predicted Industrial Fire Precaution Activity Level from the appropriate Ranger District Office before starting work each day or at: [https://publicdashboards.dl.usda.gov/t/NRE\\_PUB/views/ProjectActivityLevelPALandIndustrialFirePrecautionActivityLevelIFPAL-California\\_Web/IFPALDashboard?%3Aembed=y&%3Aiid=8&%3AisGuestRedirectFromVizportal=y](https://publicdashboards.dl.usda.gov/t/NRE_PUB/views/ProjectActivityLevelPALandIndustrialFirePrecautionActivityLevelIFPAL-California_Web/IFPALDashboard?%3Aembed=y&%3Aiid=8&%3AisGuestRedirectFromVizportal=y)

Forest Service may change the Industrial Fire Project Activity Level Table to other values upon revision of the National Fire Danger Rating System. When Purchaser is notified, the revised Industrial Fire Precaution Activity Levels will supersede the levels in the Project Activity Level Table below.

Purchaser may install a weather recording device in a location and manner agreed to by the Forest Service. Such a device shall be able to record relative humidity and temperature and have the ability to record and store data for at least fourteen days. The device shall have the capability to be accessed by the Forest Service using customarily available wireless technology.

**INDUSTRIAL FIRE PRECAUTION ACTIVITY LEVEL (IFPAL) - C7.22# - EMERGENCY PRECAUTIONS**

**PROJECT ACTIVITY LEVEL TABLE**

<b>Level</b>	<b><i>Project Activity Minimum Requirements and Restrictions. Restrictions at each level are cumulative.</i></b>
<b>1</b>	<ol style="list-style-type: none"><li>1. Minimum required by C7.22#.</li><li>2. Immediately after Mechanical Operations cease, Fire Patrol is required for one hour.</li></ol>
<b>2</b>	<ol style="list-style-type: none"><li>1. Tank truck, trailer, or approved CAFS substitute shall be on or adjacent to the Active Landing.</li><li>2. When Hot Saws are operating, a tank truck, trailer or approved CAFS substitute shall be within a 10-minute response time of these operations. Effective communications shall exist between the operator and the Active Landing.</li><li>3. No blasting, mowing, welding, cutting, or grinding of metal between 12:00 PM and 7:00 PM, unless hourly onsite recorded readings show a relative humidity above <b>25</b> percent.</li></ol>

3

1. Immediately after Hot Saw operations cease, Fire patrol is required for two hours.
2. No Welding or cutting of metal after 12:00 PM, except by special permit.
3. The following activities may operate all day:
  - a. Loading and hauling logs decked at approved landings.
  - b. Loading and hauling chips stockpiled at approved landings.
  - c. Servicing equipment at approved sites.
  - d. Dust abatement, road maintenance (Chainsaw use prohibited), culver installation within cleared area, chip sealing, paving, earth moving or rock aggregate stockpile loading and installation (does not include pit or quarry development).
  - e. Chainsaw and log processing operations associated with loading logs or other forest products at approved landings.
4. Hot saws may operate until 12:00 PM; provided that:
  - a. A tractor or other equipment with a blade capable of constructing fireline is on or adjacent to the active landing or within ten minutes of the operating equipment. This piece of equipment shall have effective communication with the Hot Saw.
  - b. Any additional restrictions specified by the Forest.
5. Hot saws may operate between 12:00 PM and 7:00 PM, if hourly onsite weather readings indicate a relative humidity above 25 percent, provided that:
  - a. A tractor or other equipment with a blade capable of constructing fireline is on or adjacent to the active landing or within ten minutes of the operating equipment. This piece of equipment shall have effective communication with the Hot Saw.
  - b. Any additional restrictions specified by the Forest.
  - c. Hot Saws shall not operate after 12:00 PM, regardless of relative humidity value, when the National Weather Service issues red flag warning(s), or fire weather watches.
6. All other conventional and Mechanical Operations are permitted until 12:00 PM. Conventional and Mechanical Operations between 12:00 PM and 7:00 PM are prohibited, unless hourly onsite weather readings indicate relative humidity values of 25 percent or greater. Regardless of relative humidity readings, no operations shall be permitted when the National Weather Service issues red flag warning (s), or fire weather watches.
7. **When relative humidity is below 25% some operations may be permitted after 12:00 PM, on a case-by-case basis, under the terms of a IFPAL Variance Agreement. Activities for which a Variance may be issued are:**
  - **Rubber Tire Skidding**

	<ul style="list-style-type: none"> <li>• <b>Cable Yarding with a non-motorized carriage</b></li> <li>• <b>Chipping on Landings</b></li> <li>• <b>Helicopter Yarding</b></li> <li>• <b>Fire Salvage</b></li> </ul> <p>When approved by a Line Officer, a Variance Agreement can be implemented when the criteria specified in the agreement are met and mitigation measures are in place. Variance approval can be withdrawn at the sole discretion of Forest Service. Variance approval is contingent on the 7-day fire weather forecast, fuel conditions, site characteristics, current fire situation, state of Purchaser's equipment for prevention and suppression readiness, type of operation and social and community considerations etc. (See attached Project Activity Level Variance Agreement).</p>
<p><b>4</b></p>	<p>The following activities may operate all day:</p> <ol style="list-style-type: none"> <li>1. Loading and hauling logs decked at approved landings.</li> <li>2. Loading and hauling chips stockpiled at approved landings.</li> <li>3. Servicing Equipment at approved sites.</li> <li>4. Dust abatement, road maintenance (chainsaw use prohibited) or loading stockpiles and rock aggregate installation (does not include pit or quarry development).</li> <li>5. Chainsaw operation associated with loading at approved landings.</li> </ol> <p>All other activities are prohibited.</p>

## **Appendix I: Advanced Technologies**

The Contractor will utilize advanced implementation technology services, as described below, which are purpose-built for land managers, foresters, and operators to increase the pace and scale of on-the ground fuels reduction and forest health work across the U.S. The Contractor shall not be liable for any loss or damage to Earth Force equipment, regardless of cause, except in cases of gross negligence or willful misconduct on the part of the Contractor. The technologies to be provided to and used by the implementation contractor are identified below:

### **1. Advanced Implementation Technologies Toolkit:**

**a. Portal:** Portal is a web application that reports on-the-ground progress to administrators, foresters, and operators. These multiple stakeholders will have visibility into field activities on demand with progress updates from the field occurring no less than weekly. Portal will allow the operating company to view and export a map and shape files of location-specific work progress and monitor key quality control metrics including: daily acres completed, acres remaining, and estimated time to project completion. Portal will also deliver pre-and post-treatment basal area per acre calculations to inform acres ready for inspection and overall prescription compliance, for areas that have been treated with a Lidar based sensor package.

**b. Sensors:** Camera-based and LiDAR-based machine mounted sensors will be deployed on equipment in two primary form factors throughout the project in order to capture images, audio, and generate precision-GPS tracks of completed work. The Rover combines GPS, audio, and time lapse video for a lightweight and passive data collection system, while the Sensor Box provides an integrated experience with high precision GPS, video, LiDAR, and feedback for the in-cab operator to guide the work in real time. This data is then provided to key stakeholders via the Portal.

**c. Hub Connectivity:** A connectivity solution at the project landing site will be deployed at the start of project implementation and as coordinated by Earth Force Technologies and the implementation contractor. Hub Connectivity will enable real-time communication and coordination between the Forester and the implementation contractor, from this landing.

**d. Guide:** Guide will be provided at the start of implementation to enhance oversight capabilities, by providing real-time alerts to in-cab operators to assist their avoiding identified no-go zones and remain within the project boundaries. Additional capabilities will be enabled through the lidar based system to provide real-time guidance such as: DBH measurement and spacing between standing trees.



**e. Updates to Toolkit:** On a monthly basis, Earth Force can have access to operator's equipment to update Earth Force's software and hardware outside of production hours, at mutually agreeable times to perform IT servicing and provide updates or improvements to ongoing capabilities.

**2. Installation:** Operator will provide machine access to Earth Force for installation of Earth Force's technology. Installation by Earth Force is simple, non-invasive and is expected to take no more than 30 minutes to 1 hour per machine. Installation will occur outside of production hours.

**a. Sensor:**

- I. **Rover:** Each machine will receive a Rover device which will be installed on the front windshield or to front A pillar inside the cab facing forward. Attachment method will be non-invasive. This device will be powered by the 12v accessory port (cigarette lighter port), ensuring USB ports remain available for the operator's devices as well.
- II. **Sensor Box:** On select machines designated in collaboration by the NFF, Forest Service, and operator, a sensor box will be fastened to the roof in a non-invasive manner. This device will require tapping into machine ACC power, either in the cab or to the machine's 12/24v DC power. Sensor box pairs with an in-cab tablet to engage with Earth Force software. This tablet will be held in a RAM mount, clamped, or bolted inside the cab and powered from the same source and in the same manner as a Rover.

**b. Hub Connectivity:**

- I. A Starlink device will be provided, for use at an active landing site ("Hub").

**3. Operator Collaboration:**

**a. Data Offload:** At least once per week on a schedule to be agreed between NFF, JRC and the Operator. Operator agrees to bring each Rover device back to a Hub for data upload in areas without cellular connectivity.

**b. Hub Connectivity:** To the extent that Hub needs to move between locations, Contractor will coordinate with Earth Force as required to facilitate.

**4. Training on Earth Force's technology:**

**a. Portal:** One hour of training will be provided at the start of the project. Quarterly update training sessions can be supported for new users, if needed.



BUILDING 27, SUITE 3, FORT MISSOULA ROAD  
MISSOULA, MONTANA 59804  
TEL 406.542.2805  
NATIONALFORESTS.ORG

**b. Guide:** This will be available to users working near project boundaries as a tablet.

**c. Updates to Toolkit:** Phone and email contacts will be provided to the contractor's supervisors for field support provided through Earth Force. Updates could include:

1. New versions of Rover Hardware (HW) or Software (SW).
2. Mounting solution updates.
3. Testing Sensor Box for a predetermined duration of time; on units that data collection and operator assistance is desired.
4. New Hub Connectivity add on solutions.

## **5. Contact**

To learn more, please reach out to [info@earthforce.io](mailto:info@earthforce.io)

# Road Maintenance Specifications

For  
Timber Sale Contracts

February 2024

## Sleighville Stewardship Agreement

Specification		Specification
Number		Title
<input checked="" type="checkbox"/>	T-800	Definitions
<input type="checkbox"/>	T-801	Slide and Slump Repair
<input checked="" type="checkbox"/>	T-802	Ditch Cleaning
<input checked="" type="checkbox"/>	T-803	Surface Blading
<input checked="" type="checkbox"/>	T-804	Surface Repair
<input checked="" type="checkbox"/>	T-805	Drainage Structures
<input checked="" type="checkbox"/>	T-806	Dust Abatement
<input checked="" type="checkbox"/>	T-807	Roadside Vegetation
<input type="checkbox"/>	T-808	Miscellaneous Structures
<input checked="" type="checkbox"/>	T-809	Waterbars
<input checked="" type="checkbox"/>	T-810	Barriers
<input type="checkbox"/>	T-811	Surface Treatment



Dust Abatement Plan (T-806) (C5-31#)(B5.3)

Timber Sale: Sleighville Stewardship Agreement

Sheet 1 of 1

Road Segment	Material Type or Grade	Applicaation Initial	Rate Subsequent	Frequency of Subsequent Applications	Preparation Method	Wt. To Volume Conversion Factor
293-02 Seg 1	Water	N/A	N/A	3 Times Daily or as Needed to Abate Dust	T-803 as Needed	N/A
293-02 Seg 2						
293-02-02						
293-18						
293-18-05-01						
293-18-08						
34-08-03						
34-13						
34-15						
34-15-01						
49-22						
34						
34-01 Seg 1						
34-01 Seg 2						
34-02						
34-03 Seg 1						
34-03 Seg 2						
34-04						
34-05 Seg 1						
34-05 Seg 2						
34-06						
34-07						
49-27						
34-02-02						
34-02-01						
34-08-02						
34-07-01						
34-09						
34-09-01						
34-11						
34-13-01						
34-08 Seg 1						
34-08 Seg 2						
293-02-03						
34-12						
293-02-02-02						
34	Magnesium Chloride	0.30 Gallon Per Square Yard	0.30 Gallon Per Square Yard	Each 2000 MBF Hauled (or as needed to abate dust)	Method 1	191 Gallons Per Ton @ 60 Degrees F.

**Road Maintenance T-Specifications**  
**for**  
**Timber Sale Contracts**

<b><u>No.</u></b>	<b><u>Specification Title</u></b>
T-800	Definitions
T-801	Slide and Slump Repair
T-802	Ditch Cleaning
T-803	Surface Blading
T-804	Surfacing Repair
T-805	Drainage Structures
T-806	Dust Abatement
T-807	Roadway Vegetation
T-808	Miscellaneous Structures
T-809	Waterbars
T-810	Barriers
T-811	Surface Treatment

## SPECIFICATION T-800 DEFINITIONS

Wherever the following terms or pronouns are used in Specifications T-801 through T-811, the intent and meaning shall be interpreted as follows:

800-1.1 - Agreement. Maintenance projects require a mutually acceptable method to resolve the problems which arise when incompatible situations arise between drawings and specifications and actual conditions on the ground to allow orderly and satisfactory progress of the maintenance.

These specifications have been developed in anticipation of those problem areas and have provided that such changes will be by agreement.

It is intended that drawings and specifications will govern unless "on-the-ground" conditions warrant otherwise, when specifications call for "Agreement", "agreed", or "approval" such agreement or approval shall be promptly confirmed in writing.

800-1.2 - Annual Road Maintenance Plan. A plan prepared by various users of one or several roads. The plan is an agreement on maintenance responsibilities to be performed for the coming year.

800-1.3 - Base Course. Material used to reinforce subgrade or, as shown on drawings, placed on subgrade to distribute wheel loads.

800-1.4 - Berm. Curb or dike constructed to prevent roadway runoff water from discharging onto embankment slope.

800-1.5 - Borrow. Select material taken from designated borrow sites.

800-1.6 - Crown, Inslope, and Outslope. The cross slope of the traveled way to aid in drainage and traffic maneuverability.

800-1.7 - Culverts. A conduit or passageway under a road, trail, or other obstruction. A culvert differs from a bridge in that it is usually entirely below the elevation of the traveled way.

800-1.8 - Drainage Dip. A dip in the traveled way which intercepts surface runoff and diverts the water off the traveled way. A drainage dip does not block the movement of traffic.

800-1.9 - Drainage Structures. Manufactured structures which control the runoff of water from the roadway including inslope, overside drains, aprons, flumes, downdrains, downpipes, and the like.

800-1.10 - Dust Abatement Plan. A table which lists the road, dust palliative, application rates, and estimated number of subsequent applications.

800-1.11 - Lead-off Ditches. A ditch used to transmit water from a drainage structure or drainage dip outlet to the natural drainage area.

800-1.12 - Material. Any substances specified for use in the performance of the work.

800-1.13 - Prehaul Maintenance. Road maintenance work which the Purchaser determines must be accomplished to maintain the roads to a satisfactory condition commensurate with the Purchaser's use, provided Purchaser's Operations do not damage improvements under B6.22 or National Forest resources and hauling can be done safely. This work will be shown in the Annual Road Maintenance Plan as provided in B/BT6.31.

Prehaul Maintenance work the Purchaser elects to perform will be in compliance with the Road Maintenance T-Specifications.

800-1.14 - Roadbed. The portion of a road between the intersection of subgrade and sideslopes, excluding that portion of the ditch below subgrade.

800-1.15 - Road Maintenance Plan. A table which shows applicable road maintenance specifications to be performed by Purchaser on specific roads.

800-1.16 - Roadside. A general term denoting the area adjoining the outer edge of the roadway.

800-1.17 - Roadway. The portion of a road within the limits of excavation and embankment.

800-1.18 - Shoulder. That portion of roadway contiguous with traveled way for accommodation of stopped vehicles, for emergency use, and lateral support of base and surface course, if any.

800-1.19 - Slide. A concentrated deposit of materials from above or on backslope extending onto the traveled way or shoulders, whether caused by mass land movements or accumulated ravelling.

800-1.20 - Slough. Material eroded from the backslope which partially or completely blocks the ditch but does not encroach on the traveled way so as to block passage of traffic.

800-1.21 - Slump. A localized portion of the roadbed which has slipped or otherwise become lower than that of the adjacent roadbed and constitutes a hazard to traffic.

800-1.22 - Special Project Specifications. Specifications which detail conditions and requirements peculiar to the individual project.

800-1.23 - Subgrade. Top surface of roadbed upon which base course or surface course is constructed. For roads without base course or surface course, that portion of roadbed prepared as the finished wearing surface.

800-1.24 - Surface Course. The material placed on base course or subgrade primarily to resist abrasion and the effects of climate. Surface course may be referred to as surfacing.



800-1.25 - Surface Treatment Plan. A table which lists the roads and surface treatments to be applied.

800-1.26 - Traveled Way. That portion of roadway, excluding shoulders, used for the movement of vehicles.

800-1.27 - Turnouts. That portion of the traveled way constructed as additional width on single lane roads to allow for safe passing of vehicles.

800-1.28 - Water Source. A place designated on the Sale Area Map for acquiring water for road maintenance purposes.

800-1.29 - Waterbar. A dip in the roadbed which intercepts surface runoff and diverts the water off the roadway. A waterbar is not designed to be traversable by logging trucks.

## **SPECIFICATION T-801 SLIDE AND SLUMP REPAIR**

### **DESCRIPTION**

1.1 Slide removal is the removal from Roadway and disposal of any Material, such as soil, rock, and vegetation that cannot be routinely handled by a motorgrader during Ditch Cleaning, T-802, and Surface Blading, T-803 Operations.

Slump repair is the filling of depressions or washouts in Roadway which cannot be routinely filled by a motor grader during Surface Blading, T-803 Operations.

Slide removal and Slump repair includes excavation, loading, hauling, placing, and compacting of waste or replacement Material and the development of disposal or borrow areas.

### **REQUIREMENTS**

3.1 Slide Material, including soil, rock and vegetative matter which encroaches into the Roadway, shall be removed. The slope which generated the Slide Material shall be reshaped during the removal of the Slide Material with the excavation and loading equipment. Slide Material deposited on the fillslope and below the Traveled Way will not be removed unless needed for slope stability or to protect adjacent resources.

Surface and Base Courses shall not be excavated during Slide removal operations.

Slide Material which cannot be used for other beneficial purposes shall be disposed of at disposal sites shown on Sale Area Map. Material placed in disposal sites will not require compaction unless compaction is shown on Road Maintenance Plan.

3.2 When filling Slumps or washouts, Material shall be moved from agreed locations or borrow sites shown on Sale Area Map, placed in layers, and compacted by operating the hauling and spreading equipment uniformly over the full width of each layer.

Existing aggregate surfacing shall be salvaged when practical and relaid after depressions have been filled.

Damaged aggregate base, aggregate surfacing, and bituminous pavement shall be repaired under Specification T-804 Surfacing Repair.

The repaired areas of the Slump shall conform to the cross-section which existed prior to the Slump and shall blend with the adjacent undisturbed Traveled Way.

3.3 The maximum volume of Purchaser responsibility for Slide and Slump repair is shown on Road Maintenance Plan. Greater volumes of Slide and Slump repair not qualifying as Catastrophic Damage are Forest Service responsibility.

## **SPECIFICATION T-802 DITCH CLEANING**

### **DESCRIPTION**

1.1 Ditch cleaning is removing and disposing of all Slough Material from Roadway ditches to provide a free-draining waterway.

### **REQUIREMENTS**

3.1 Ditch cleaning shall be repeated during the year as often as necessary to facilitate proper drainage.

3.2 All Slough Material or other debris which might obstruct water flow in the Roadway ditch shall be removed. Material removed from the ditch, if suitable, may be blended into existing native road surface or Shoulder or placed in designated Berms in conjunction with Surface Blading T-803 operations.

Material removed from ditches that is not by Agreement blended into existing roads or placed in Berms shall be loaded and hauled to the disposal site shown on Sale Area Map.

3.3 Roadway backslope or Berm shall not be undercut.

## **SPECIFICATION T-803 SURFACE BLADING**

### **DESCRIPTION**

1.1 Surface blading is keeping a native or aggregate Roadbed in a condition to facilitate traffic and provide proper drainage. It includes maintaining the Crown, Inslope or Outslope of the Traveled Way, Turnouts, and Shoulder; repairing Berms; blending approach road intersections; and cleaning bridge decks, Drainage Dips, and Lead-off Ditches.

### **REQUIREMENTS**

3.1 Surface blading shall be performed before, during, and after Purchaser's use as often as necessary to facilitate traffic and proper drainage.

3.2 The surface blading shall preserve the existing cross-section. Surface irregularities shall be eliminated and the surface left in a free-draining state and to a smoothness needed to facilitate traffic. Surface Material which has been displaced to the Shoulders or Turnouts shall be returned to the Traveled Way. The blading operation shall be conducted to prevent the loss of surface Material and to provide for a thorough mixing of the Material being worked.

3.3 Water, taken from Water Sources designated on Sale Area Map, shall be applied during blading if sufficient moisture is not present to cut, mix, or compact the surface Material.

3.4 On native surfaced roads, Material generated from backslope Sloughing, and ditch cleaning may be blended with the surface Material being worked. On aggregate surfaced roads this Material shall not be blended with Surface or Base Course Material unless agreed otherwise.

3.5 Roadway backslopes or Berms shall not be undercut, nor shall new Berms be established unless agreed otherwise.

Berms shall be repaired by placing Material, as needed to restore the Berm, to reasonably blend with existing line, grade, and cross-section.

3.6 Drainage Dips and Lead-off Ditches shall be cleaned and maintained to reasonably blend with existing line, grade, and cross-section.

3.7 Intersecting roads shall be bladed for a distance of 50 feet to assure proper blending of the two riding surfaces.

3.8 Rocks or other Material remaining on the Traveled Way after the final pass that are larger than 4 inches in diameter or are larger than the maximum size of imported surfacing shall be removed from the Traveled Way. The oversized Material shall be disposed of by sidecasting, unless shown otherwise on Sale Area Map. Sidecasting into streams, lakes, or water courses will not be permitted.

3.9 Material resulting from work under this specification shall not remain on or in structures, such as Culverts, overside drains, cattleguards, ditches, Drainage Dips, and the like.

3.10 Material resulting from work under this specification, plus any accumulated debris, shall be removed from bridge decks and the deck drains opened.

## **SPECIFICATION T-804 SURFACING REPAIR**

### **DESCRIPTION**

1.1 Surfacing repair is repairing potholes or small soft areas in the Traveled Way. It includes area preparation and furnishing and placing all necessary Materials, and other work necessary to repair the surface.

### **MATERIALS**

2.1 Material used in the repair of soft areas on aggregate or native surfaced roads may be acquired from approved commercial sources, Forest Service Borrow areas shown on Sale Area Map, or Borrow sources agreed to. The quality and quantity of the imported Material used in the repair will be limited to that needed to provide a stable Traveled Way for hauling and to minimize damage to the road and adjacent resources. The quantity of imported surface repair Material used in the appraisal estimate will be shown on Road Maintenance Plan. However, the magnitude of the work may vary depending on Purchaser's hauling schedule and ground conditions.

2.2 Material used in the repair of bituminous pavements may be acquired from local commercial sources. If a mixing table is required, the location shall be approved by the Forest Service. The bituminous mixture to be used by the Purchaser shall be approved by the Forest Service. The Purchaser's share of the quantity of bituminous mixture used in the appraisal estimate will be shown on Road Maintenance Plan. However, Purchaser's share of the work may vary depending on Purchaser's hauling schedule, ground conditions, other traffic, etc.

### **REQUIREMENTS**

3.1 Work under this specification shall be performed in a timely manner to reduce further deterioration of the Traveled Way.

3.2 Soft spots on aggregate or native surfaces shall be repaired by placing the imported Surface Course on top of the soft spot. Layers of imported Material shall be placed until a firm surface is produced.

3.3 Bituminous Pavement Repairs. The areas to receive bituminous pavement repairs will be marked on the road surface by the Forest Service just prior to Purchaser performing the work.

3.4 Potholes (deep patch). Surface Course and Base Course Materials shall be excavated to a depth necessary to reach firm, suitable Material. The minimum depth of excavation shall be 2 inches and the maximum depth of excavation shall be to the top of the Subgrade.

The edges of the prepared hole shall be extended to form a vertical face in unfractured asphalt surfacing. The prepared hole shall generally be circular or rectangular in shape, dry, and cleaned of all loose Material.

Prepared potholes shall be patched or barricaded immediately.

The faces of the prepared hole shall be tacked with a slow-setting emulsified asphalt.

The bituminous mixture shall be placed in layers not exceeding a compacted depth of 2 inches. Each layer shall be compacted thoroughly with hand or mechanical tampers or rollers. Compaction shall not be done with equipment wheels.

Upon completion, the compacted patch in the pothole shall be flush, with a tolerance or approximately ¼ inch to ½ inch above the level of the adjacent pavement.

3.5 Skin Patches. Prior to skin patching, potholes shall be patched and the surface shall be cleaned of loose and deleterious material. Apply a tack coat with a slow-setting emulsified asphalt at the rate of 0.1 gallons per square yard. Bituminous mixture shall be distributed uniformly with feathered edges in layers not to exceed 2 inches compacted depth. When multiple layers are ordered, joints shall be offset at least 6 inches between layers.

Each layer shall be compacted by two passes with a 7-10 ton steel roller or comparable vibratory roller.

3.6 Asphalt Berm. Damaged segments of Berm shall be removed and the exposed ends beveled at approximately 45 degrees from vertical. The Berm foundation shall be cleaned and patched as necessary. The foundation and joining surfaces shall be coated with a slow-setting emulsified asphalt. Asphalt mix shall be placed and compacted to conform with the shape and alignment of the undamaged segment.

3.7 Disposal. All Materials removed from potholes, patches, and Berms shall be disposed of at disposal sites shown on Sale Area Map.

## **SPECIFICATION T-805 DRAINAGE STRUCTURES**

### **DESCRIPTION**

1.1 This work consists of maintaining Drainage Structures and related items such as inlet and outlet channels, existing riprap, trash racks, and drop inlets.

### **MATERIALS**

2.1 All Materials used in the maintenance of Drainage Structures shall conform by type and specification to the Material in the structure being maintained.

### **REQUIREMENTS**

3.1 Drainage Structures and related items shall be cleared of all foreign Material which has been deposited above the bottom of the structure and all vegetative growth which interferes with the flow pattern. Material removed that cannot be incorporated into maintenance work shall be hauled to a disposal site shown on Sale Area Map.

3.2 If outlet or inlet riprap was installed by Purchaser as a construction item or existed prior to Purchaser's haul, it shall be maintained in good condition including the replacement of riprap if necessary to previous line, grade, and cross-section.

3.3 Perform maintenance to insure the proper functioning of the head walls, aprons, inlet assemblies, overside drains, riprap, trash racks, and other facilities related to the Drainage Structure.



## **SPECIFICATION T-806 DUST ABATEMENT**

### **DESCRIPTION**

1.1 This work shall consist of preparing Traveled Way and furnishing and applying Materials to abate dust.

### **MATERIALS**

2.1 The roads requiring dust abatement, type of dust abatement Material to be used, the rates of application, and frequency of applications will be shown on Dust Abatement Plan (B/BT5.3, B/BT6.31, and C/CT5.31#). The Dust Abatement Plan may be changed by written Agreement.

2.2 Water. The locations of Water Sources are shown on Sale Area Map.

2.3 Dust abatement Materials shall meet the requirements of the following subsections of Forest Service Specifications for Construction of Roads and Bridges or attached Special Project Specifications.

Emulsified Asphalt	702
Blotter Material	703.12
Magnesium or Calcium Chloride Brine	723.01
Calcium Chloride Flake	723.02
Lignin Sulfonate	723.03

2.4 Testing of Materials. Certification and sampling of bituminous Materials lignin sulfonate, and magnesium chloride shall be in accordance with subsections 105.04 or 723.04 of Forest Service Specifications for Construction of Roads and Bridges.

### **REQUIREMENTS**

3.1 General. Dust abatement Materials shall be applied to the road surface as necessary to control road surface loss, provide for road user safety, and minimize damage to adjacent resources.

3.2 Compaction. When the methods listed below specify compaction, Traveled Way shall be compacted by an 8 to 10 ton pneumatic, steel-wheeled or equivalent vibrating roller making 2 passes over the full Traveled Way and Shoulder width, unless compaction is not required on the Dust Abatement Plan (B/BT5.3, B/BT6.31, and C/CT5.31#).

3.3 Preparation to Dust Abatement Materials Other Than Water. The following applies to all methods of preparation:

Bituminous residue shall be scarified and pulverized to produce loosened Material not exceeding 4 inches in greatest dimension.

Traveled Way shall be bladed in accordance with T-803.

Prior to applying DO-6BA, DO-6PA, or DO-8, the top 2 inches of Traveled Way shall contain not less than 80 percent nor more than 120 percent of optimum moisture as determined by AASHTO T-99, Method C. Prior to applying other bituminous Material, Traveled Way shall have a moisture content between 1 and 3 percent. If surface dusting prevents the bituminous Material from penetrating, a light application of water shall be applied just prior to applying the bituminous Material.

Lignin Sulfonate and magnesium chloride shall be applied when the top 1 inch of Traveled Way contains not less than 3 percent moisture, nor more than 120 percent of optimum moisture as determined by AASHTO T-99, Method C.

Moisture content will be determined in accordance with AASHTO T-217 OR T-239.

One or more of the following methods shall be used, as specified in the Dust Abatement Plan (B/BT5.3, B/BT6.31, and C/CT5.31#).

Method 1. Compact Traveled Way and apply the dust abatement Material.

Method 2. Develop a layer of loose Material approximately 1 inch in depth for the full width of Traveled Way. Apply the dust abatement Material to this loose Material and compact after penetration. If traffic makes maintenance of the loose Material difficult, 1 inch of the Material may be bladed into a windrow along the Shoulder. The specified moisture content shall be maintained in the windrow and the top 1 inch of Traveled Way. The windrow shall be bladed to a uniform Material. When the dust abatement Material has penetrated, Traveled Way shall be compacted.

Method 3. Blade 1 inch of Material from Traveled Way into a windrow along the Shoulder. Maintain the specified moisture content in the windrow and the top inch of Traveled Way. Apply half the dust abatement Material. When the dust abatement Material has penetrated, the windrow shall be bladed to a uniform depth across dust abatement Traveled Way, and the remaining dust abatement Material shall be applied. Traveled Way shall be compacted.

Method 4. Develop a layer of loose Material approximately 2 inches in depth for the full width of Traveled Way. Apply half the dust abatement Material to the loose Material. Blade the top 2 inches into a windrow along the Shoulder. Apply the remaining dust abatement Material to Traveled Way and the Berm. Spread the Berm evenly across Traveled Way and compact.

3.4 Preparation for Dust Abatement with Water. Traveled Way shall be prepared in accordance with Specification T-803 Surface Blading when required.

3.5 Application Tolerance. Dust abatement Materials other than water shall be applied within 0.05 gallons per square yard of the rate specified.

3.6 Mixing Requirements. DO-6BA, DO-6PA, and DO-8 shall be thoroughly circulated in the distributor within 1 hour of application.

3.7 Weather Limitations. Dust abatement Materials shall not be applied when it is raining.

Bituminous Material shall be applied when the surface temperature of Traveled Way is 50 degrees Fahrenheit or higher.

Lignin sulfonate and magnesium chloride shall be applied when the atmospheric temperature is 40 degrees Fahrenheit or higher.

3.8 Blotter Material. Blotter Material shall be spread in a sufficient quantity to prevent tire pickup.

## **SPECIFICATION T-807 ROADWAY VEGETATION**

### **DESCRIPTION**

1.1 This work includes removal of brush and trees from within the Roadway limits.

### **REQUIREMENTS**

3.1 Vegetative matter within the Roadway which impedes vehicular travel or interferes with road maintenance operations, such as surface blading and ditch and culvert cleaning shall be removed. Downed timber meeting utilization standards shall be cut in appropriate lengths and decked along the Roadside in locations where the Traveled Way or sight distances will not be impaired.

3.2 Vegetative matter removed from the Roadway shall be treated by the specified method shown on Sale Area Map and as required by C/CT6.7#.

## **SPECIFICATION T-808 MISCELLANEOUS STRUCTURES**

### **DESCRIPTION**

1.1 Maintenance of miscellaneous structures includes cattleguards, gates, and other similar structures that have been previously installed to insure safe and efficient operation of the road.

### **MATERIALS**

2.1 Any Materials needed in the maintenance of miscellaneous structures shall be similar in type and quality to the Material in the structure being maintained.

### **REQUIREMENTS**

3.1 Cattleguards. Loose rails shall be welded or bolted back in place.

Excess Material carried into the cattleguard shall be removed when drainage is blocked or when it reaches 6 inches from the bottom of the cattleguard frame. Drainage into and from the cattleguard shall be kept open.

3.2 Gates. Gates shall be kept in good repair and made to swing easily. Hinges or latches shall be repaired if not operating properly.

Brush and debris shall be removed from within the swinging radius.

## **SPECIFICATION T-809 WATERBARS**

### **DESCRIPTION**

1.1 This work consists of installing or removing Waterbars in the Roadbed.

### **REQUIREMENTS**

3.1 Waterbars shall be installed on roads shown on Road Maintenance Plan in accordance with the attached drawings and at locations designated or staked on the ground.

All Material excavated shall be used in the installation of the Waterbar. Bermed Material shall be compacted by operating heavy equipment over the length and width of the Berm.

3.2 Waterbars shall be removed on roads shown on Road Maintenance Plan by blading the Berm into the adjacent depression to form a smooth transition along the Traveled Way. The length and width of the fill Material shall be compacted by the equipment performing the work.

3.3 Waterbars may be required to be installed between seasons of use and then removed when haul is resumed. Waterbar installation may also be required when use of a road has been completed.

## **SPECIFICATION T-810 BARRIERS**

### **DESCRIPTION**

1.1 This work shall consist of furnishing, installing, or removing barriers. Gates are not included.

### **MATERIALS**

2.1 Materials for barriers shall meet the requirements as shown on attached drawings.

### **REQUIREMENTS**

3.1 Barriers shall be installed in accordance with the attached drawings.

The location of barriers to be removed or installed is shown on Sale Area Map. Installation or removal may occur as often as road use is terminated and resumed.

## **SPECIFICATION T-811 SURFACE TREATMENT**

### **DESCRIPTION**

1.1 This work shall consist of applying a chip seal, sand seal, or fog seal to the Traveled Way.

Chip seals may consist of single or double applications of bituminous Material and cover aggregate.

### **MATERIALS**

2.1 The roads requiring surface treatments, the type of seal coat to be applied, the rate of application, and type and grade of bituminous Material, and the rate of application and grading of cover aggregate will be shown on Surface Treatment Plan (B/BT5.3, B/BT6.31, and C/CT5.31#).

2.2 Emulsions used for fog seals shall be diluted with an equal amount of water and shall be applied at the diluted application rate shown on Surface Treatment Plan (B/BT5.3, B/BT6.31, and C/CT5.31#).

2.3 Seal coat Materials shall meet the requirements of the following subsections of Forest Service Specifications for Construction of Roads and Bridges or attached Special Project Specifications:

#### Bituminous Materials

Asphalt Cement	702.01
Liquid Asphalts	702.02
Emulsified Asphalt	702.03
Application Temperatures	702.04

Cover Aggregate	703.11
Blotter Material	703.12
Water for Diluting	725.01

2.4 The cover aggregate shall be surface damp at the time of application when using emulsified asphalt and dry when using an asphalt cement or liquid asphalt. Excess water on the aggregate surface will not be permitted.

### **REQUIREMENTS**

3.1 Traffic. Traffic shall be maintained in accordance with B/BT6.33.

3.2 Weather Limitations. Fog seal and chip seal shall not be applied when the weather is foggy or rainy.

Seal coats requiring cover aggregate shall not be applied when the temperature of the surface being treated is below 70 degrees Fahrenheit in the shade.



Fog seal coats shall not be applied when the surface temperature is below 40 degrees Fahrenheit in the shade.

3.3 Equipment. The following equipment or its equivalent shall be used:

A distributor truck equipped to spread the Material uniformly at the designated rate, within the temperature range specified and within 0.04 gallons per square yard of the rate specified. The distributor shall be equipped with a thermometer and a hand hose with spray nozzle.

A rotary power broom and/or blower.

When cover aggregates are applied: A pneumatic tire roller, 8-ton minimum weight with all tires equally inflated to a pressure of at least 90 pounds per square inch. Rollers shall be equipped with devices for applying water to the tires.

Self-propelled aggregate spreader supported by at least four wheels equipped with pneumatic tires on two axles, situated so that at no time will the tires contact the uncovered bituminous Materials. The aggregate spreader shall be equipped with positive controls so that the required amount of Materials will be deposited uniformly over the full width.

Trucks with spreading attachments shall not be used.

3.4 Preparation of Surface. Immediately before applying the bituminous Material, the surface to be sealed shall be cleaned of all foreign and loose Material.

3.5 Application of Bituminous Material. Bituminous Material shall be applied in a uniform, continuous spread. The distributor shall be moving forward at proper application speed at the time the spray bar is opened. Skipped areas or deficiencies shall be corrected prior to the application of cover aggregate.

The spread of bituminous Material shall not be more than 6 inches wider than the width to be covered by the cover aggregate. Operations shall not proceed if the bituminous Materials are allowed to cool, set up, dry, or otherwise impair retention of cover aggregate.

Fog seal shall be allowed to penetrate and dry before traffic is permitted on the sealed portion.

The surfaces of structures and trees adjacent to the area being treated shall be protected to prevent their being spattered or marred.

3.6 Application of Cover Aggregate and Blotter. Immediately following the application of the bituminous Material, cover aggregate shall be spread at the specified rate. Joints between adjacent applications of cover aggregate shall be approximately in the center of two-lane roads.

The aggregate spreader shall not be operated at speeds which cause the aggregate to roll over after striking the bituminous Material. The cut-off of aggregate shall be complete, and any excess aggregate shall be removed from the surface prior to resuming operations. Immediately after the cover aggregate has been spread, any piles, ridges, and uneven distribution shall be corrected.

Cover aggregate may be applied by hand in areas inaccessible to spreading equipment.

Rolling shall begin immediately after spreading the cover aggregate and shall consist of a minimum of two complete coverages.

The second treatment of a double chip seal shall not be applied until at least 24 hours after completion of a first treatment, when an emulsion or asphalt cement is used. If a medium cure liquid asphalt is used, 48 hours shall be allowed between applications. Prior to the second treatment, any loose cover aggregate remaining on the surface after the first treatment shall be removed in such a manner that the cover aggregate set in the bituminous material will not be displaced.

After rolling, traffic shall be controlled to a maximum speed of 15 miles per hour for a period of 4 hours.

The day following the final application of cover aggregate, any concentrations of loose cover aggregate shall be redistributed without disturbing the embedded aggregate. Four days after the final application of cover aggregate, all excess cover aggregate shall be removed. During this period, any bituminous Material that comes to the surface shall be covered with additional cover aggregate or approved blotter Material.

3.7 Blotter Material for fog seals shall be spread in sufficient quantity to prevent tire pickup.

## Sleighville Road Reconstruction

Road Number	Road Name	Reconstruction Miles	Design Standard
34	Jouberts	43 points over 12.06mi	S-5
34-02	Pourier Creek	0.06	S-5
34-02-01	Pourier Creek Spur	0.2	S-5
34-03	Pourier Creek Spur	1.8	S-5
34-04	Jouberts Spur	0.3	S-5
34-05 Seg 1	Indian Hill North	0.18	S-5
34-05 Seg 2	Indian Hill North	0.37	S-5
34-06	Jouberts Spur	0.17	S-5
34-07	Jouberts Spur	1.71	S-5
34-07-01	Skinner Spur	0.2	S-5
34-08	Upper Indian Creek	2.16	S-5
34-09	Little Humbug	0.3	S-5
34-09-01	Little Humbug Spur	0.46	S-5
34-11	Twin Quartz Spur	0.3	S-5
34-13-01	Twin Quartz Spur	0.53	S-5
Total		20.8	

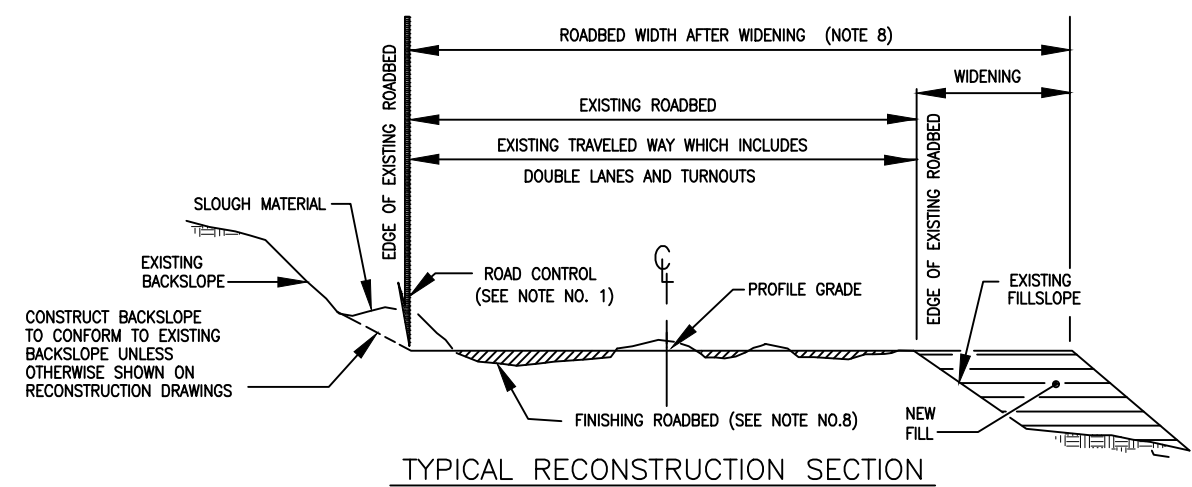

TYPICAL RECONSTRUCTION SECTION

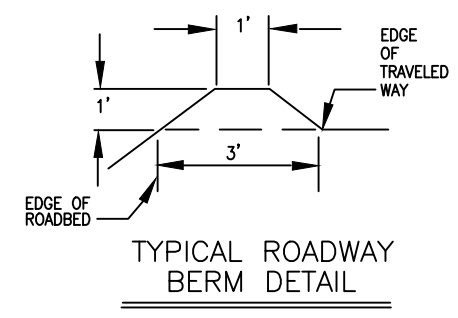

TYPICAL ROADWAY BERM DETAIL

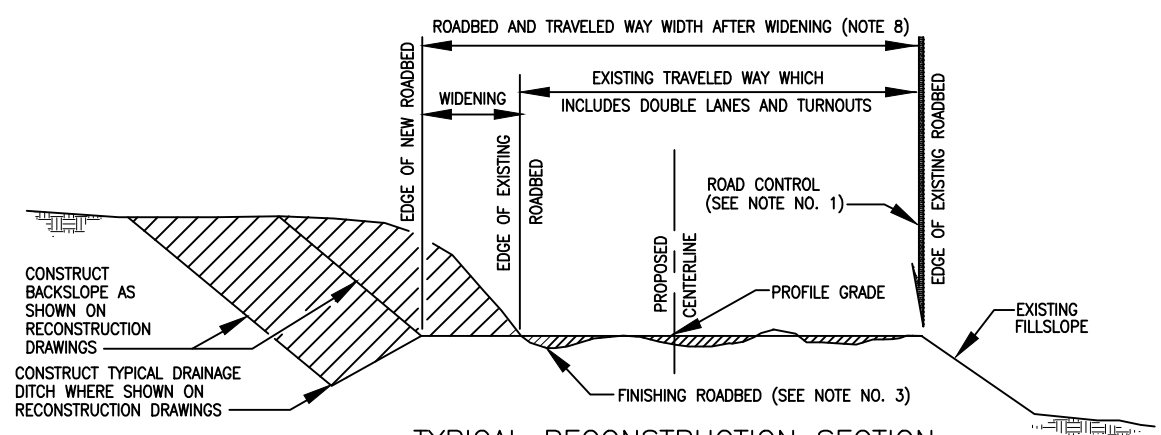

TYPICAL RECONSTRUCTION SECTION SHOWING WIDENING AND DRAINAGE DITCH

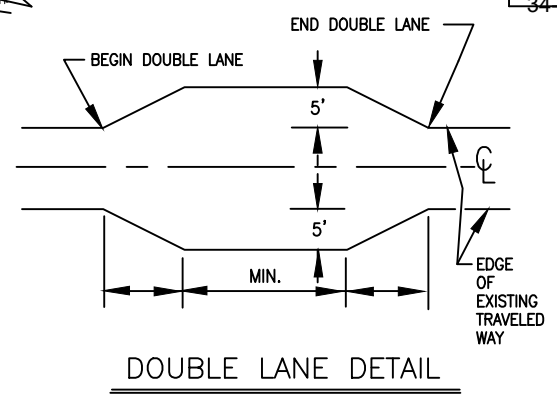

DOUBLE LANE DETAIL

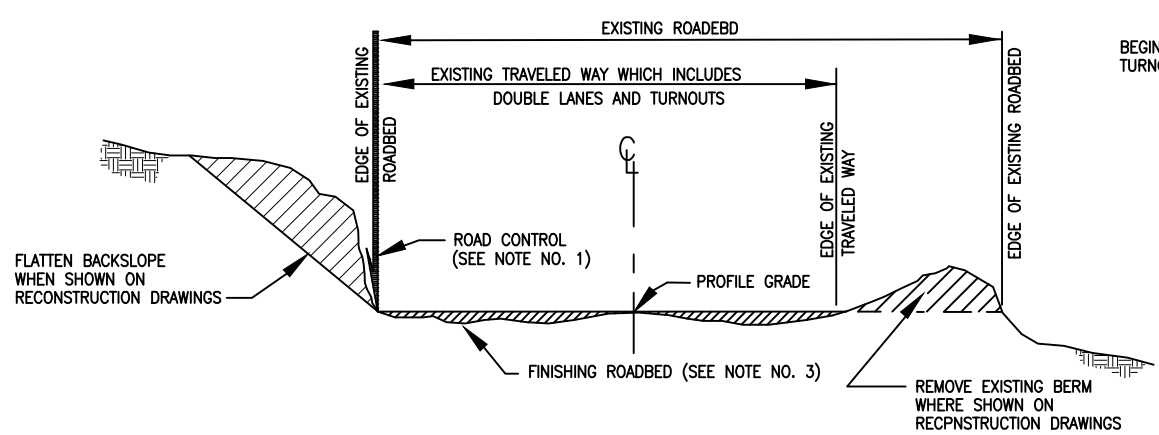

TYPICAL RECONSTRUCTION SECTION SHOWING FLATTER BACKSLOPE AND BERM REMOVAL

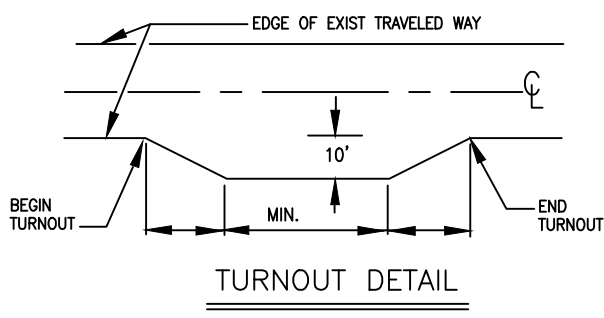

TURNOUT DETAIL

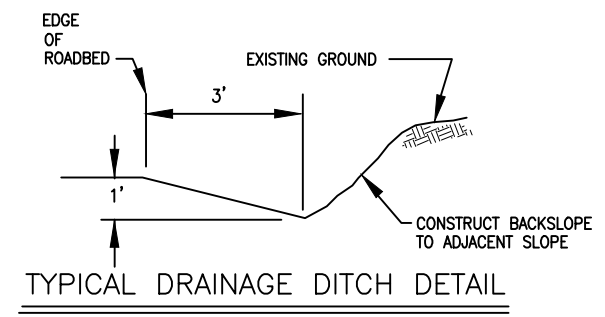

TYPICAL DRAINAGE DITCH DETAIL

CONSTRUCTION SCHEDULE								
ROAD NUMBER	SLASH TREATMENT METHODS			EMBANKMENT PLACEMENT METHODS	TOLERANCE CLASS	PAVEMENT STRUCTURE		
	TOPS & LIMBS	LOGS	STUMPS			STA. TO STA.	DEPTH	TYPE
34								
34-02	METHOD H	DECK	METHOD F					
34-02-01								
34-03								
34-04								
34-05								
34-06								
34-07								
34-08								
34-09								
34-09-01								
34-11								
34-13-01								

- NOTES:
- ROAD CONTROL**  
WHEN SHOWN ON THE RECONSTRUCTION DRAWINGS, ROAD CONTROL SHALL BE THE POINT FROM WHICH ALL WIDTH MEASUREMENTS ARE MADE.
  - FINISHING ROADBED**  
ALL AREAS SHOWN ON THE RECONSTRUCTION DRAWINGS WHERE WORK IS REQUIRED SHALL BE SHAPED AND DRESSED.
  - TRAVELED WAY WIDTH**  
TRAVELED WAY WIDTH SHALL REMAIN AS EXISTING UNLESS SPECIFIED OTHERWISE ON THE RECONSTRUCTION DRAWINGS.
  - CROSS SLOPE**  
ESTABLISH 2-4% CROSS SLOPE WHERE PRACTICAL, OTHERWISE CROSS SLOPE SHALL REMAIN AS EXISTING UNLESS SPECIFIED OTHERWISE ON THE RECONSTRUCTION DRAWINGS.
  - EXCESS EXCAVATION**  
UNLESS SPECIFIED OTHERWISE ON THE RECONSTRUCTION DRAWINGS, EXCESS EXCAVATION FROM WIDENING ROADBED, FLATTENING BACKSLOPES, TURNOUTS, DOUBLE LANES, DITCHES, DIPS, SLOUGH MATERIAL AND BERM REMOVAL SHALL BE PLACED AND SPREAD ON ROADBED.
  - BERM REMOVAL**  
WHEN SPECIFIED ON THE RECONSTRUCTION DRAWINGS, BERMS SHALL BE REMOVED TO THE EXISTING SUBGRADE ELEVATION AND SHALL CONFORM TO EXISTING CROSS SLOPE.
  - WIDENING**  
WIDENING DISTANCE AND WIDTH AFTER WIDENING IS SHOWN ON THE RECONSTRUCTION PLANS.

RECONSTRUCTION REQUIREMENTS		
PROJECT NAME	SHEET NUMBER	OF SHEETS
Sleighville SA	1	6

# Reconstruction Plans

Road Number: 34

Backslope 0.75:1

Road Name: **Jouberts**

Fillslope 1.5:1

Minimum Travel Way = 14'

<u>Mile Post</u>	<u>Description of work</u>
<b>0</b>	Begin reconstruction at intersection with CA-49. Bit surface. Begin brushing both sides of roadbed. Logout approx 10 trees per mile
<b>0.02</b>	Pothole patching, approx 8 sf.
<b>0.03</b>	Culvert. No action needed
<b>0.06</b>	Culvert clean and brush inlet and outlet
<b>0.07</b>	Begin maintaining ditch, left
<b>0.08</b>	Gravel surface. Begin blading and shaping
<b>0.18</b>	Maintain dip. End ditch maintenance
<b>0.21</b>	Culvert. Clean inlet and outlet
<b>0.24</b>	Begin maintaining ditch, right.
<b>0.29</b>	Culvert. Clean and brush inlet and outlet
<b>0.31</b>	Maintain dip.
<b>0.39</b>	Culvert clean and brush inlet and outlet
<b>0.43</b>	Maintain dip
<b>0.44</b>	Maintain dip
<b>0.49</b>	Culvert clean inlet and outlet
<b>0.53</b>	Maintain dip
<b>0.6</b>	Reconstruct leadout, left.
<b>0.89</b>	Maintain dip
<b>0.93</b>	Culvert clean and brush inlet and outlet
<b>0.95</b>	Reconstruct dip
<b>1.03</b>	Reconstruct dip
<b>1.24</b>	Culvert. Clean and brush inlet and outlet
<b>1.26</b>	34-01 spur, right. Continue straight
<b>1.31</b>	Culvert. Clean and brush inlet and outlet
<b>1.35</b>	Reconstruct dip
<b>1.64</b>	Road surface is bituminous. Do not blade.
1.66	Culvert. Clean and brush inlet and outlet
1.76	Culvert. Clean and brush inlet and outlet

# Reconstruction Plans

Road Number: 34

Backslope 0.75:1

Road Name: Jouberts

Fillslope 1.5:1

Minimum Travel Way = 14'

<u>Mile Post</u>	<u>Description of work</u>
1.9	Culvert. Clean and brush inlet and outlet
2.04	Culvert. Clean and brush inlet and outlet
2.09	Begin pothole patching, approx 400sf over next 0.28mi
2.21	Culvert. Clean and brush inlet and outlet
2.3	Culvert. Clean and brush inlet and outlet
2.36	End pothole patching
2.37	Gravel surface, resume blading and shaping
2.4	Reconstruct dip
2.43	Culvert. Clean and brush inlet and outlet
2.5	Reconstruct dip. Culvert. Clean and brush inlet and outlet
2.58	Reconstruct dip
2.6	Culvert. Clean and brush inlet and outlet
2.66	Intersection with 34-02 left and 34-03 right. Continue straight.
2.69	Culvert. Clean and brush inlet and outlet
2.79	Culvert. Clean and brush inlet and outlet
2.88	Culvert. Clean and brush inlet and outlet
3	Culvert. Clean and brush inlet and outlet
3.09	Culvert. Clean and brush inlet and outlet
3.24	Culvert. Clean and brush inlet and outlet
3.31	Culvert. Remove boulder from inlet basin. Clean and brush inlet and outlet
3.4	Culvert. Clean and brush inlet and outlet
3.51	Culvert. Clean and brush inlet and outlet
3.6	Culvert. Clean and brush inlet and outlet
3.69	Culvert. Clean and brush inlet and outlet
3.92	Culvert. Clean and brush inlet and outlet
4.03	34-04 spur right. Continue straight
4.19	Culvert. Clean and brush inlet and outlet

# Reconstruction Plans

Road Number: 34

Backslope 0.75:1

Road Name: **Jouberts**

Fillslope 1.5:1

Minimum Travel Way = 14'

<u>Mile Post</u>	<u>Description of work</u>
4.21	Spur left, continue straight.
4.37	Culvert. Clean and brush inlet and outlet
4.52	Culvert. Clean and brush inlet and outlet
4.59	Reconstruct dip and leadout.
4.68	Reconstruct dip and leadout
4.71	Culvert. Clean and brush inlet and outlet
4.72	34-05 spur, left. Continue straight.
4.77	Culvert. Clean and brush inlet and outlet
5	Culvert. Clean and brush inlet and outlet
5.12	Culvert. Clean and brush inlet and outlet
5.25	Culvert. Clean and brush inlet and outlet
5.3	Culvert. Clean and brush inlet and outlet
5.31	Reconstruct dip. Ensure overside drain is clear
5.44	Reconstruct dip and leadout.
5.52	Construct dip
5.61	Reconstruct dip
5.65	Culvert. Clean and brush inlet and outlet
5.67	Construct dip
5.7	34-07 spur right. Continue straight
5.76	Reconstruct dip
5.81	Culvert. Clean and brush inlet and outlet
5.83	Reconstruct dip
6.04	Reconstruct leadout, left
6.08	Culvert. Clean and brush inlet and outlet
6.19	Reconstruct dip
6.27	Culvert. Clean and brush inlet and outlet
6.29	Culvert. Clean and brush inlet and outlet
6.3	Ensure overside drain is clear and effective
6.4	Reconstruct dip. Ensure overside drain is clear

# Reconstruction Plans

Road Number: 34

Backslope 0.75:1

Road Name: **Jouberts**

Fillslope 1.5:1

Minimum Travel Way = 14'

Mile Post	Description of work
6.7	Reconstruct dip
6.76	Reconstruct dip. Ensure overside drain is clear
6.85	Reconstruct dip
6.87	Culvert. Clean and brush inlet and outlet
6.9	Culvert. Clean and brush inlet and outlet
7.03	Culvert. Clean and brush inlet and outlet
7.07	Ensure overside drain clear
7.141	Ensure overside drain clear
7.24	Reconstruct dip
7.29	Culvert. Clean and brush inlet and outlet
7.59	Culvert. Clean and brush inlet and outlet
7.62	Culvert. Clean and brush inlet and outlet
7.72	Reconstruct dip
7.88	Culvert. Clean and brush inlet and outlet
7.91	Reconstruct dip
8	Reconstruct dip
8.06	Culvert. Clean and brush inlet and outlet
8.15	Maintain dip
8.22	Culvert. Clean and brush inlet and outlet
8.26	Reconstruct dip
8.55	Intersection. 34-12 right, 34-13 left. Continue straight.
8.57	Begin maintaining ditches both sides of road.
8.7	End ditch maintenance. Culvert. Clean and brush inlet and outlet
8.73	Reconstruct dip
8.77	Culvert. Clean and brush inlet and outlet
8.79	Reconstruct dip
8.83	Begin maintaining ditch, right.
8.89	End ditch maintenance
8.9	Culvert. Clean and brush inlet and outlet



# Reconstruction Plans

Road Number: 34

Backslope 0.75:1

Road Name: **Jouberts**

Fillslope 1.5:1

Minimum Travel Way = 14'

Mile Post	Description of work
8.94	Construct dip. Culvert. Clean and brush inlet and outlet
8.97	Maintain dip
9.06	Culvert. Clean and brush inlet and outlet
9.07	34-58 spur right, continue straight
9.08	Water hole. Left side. Marked by FS sign
9.19	Maintain dip
9.26	Maintain dip. Ensure overside drain clear
9.29	Culvert. Clean and brush inlet and outlet
9.32	Culvert. Clean and brush inlet and outlet
9.47	Reconstruct dip
9.54	Reconstruct dip
9.56	Culvert. Clean and brush inlet and outlet
9.65	Reconstruct dip
9.73	Culvert. Clean and brush inlet and outlet
9.72	Maintain dip
9.77	Culvert. Clean and brush inlet and outlet
9.8	Maintain dip. Ensure overside drain is clear
9.84	Culvert. Clean and brush inlet and outlet
9.97	Construct dip
9.98	Culvert. Clean and brush inlet and outlet
10	Reconstruct dip
10.01	Culvert. Clean and brush inlet and outlet
10.02	Culvert. Clean and brush inlet and outlet
10.08	Reconstruct dip
10.12	Culvert. Clean and brush inlet and outlet
10.16	Reconstruct dip. Ensure overside drain clear
10.26	Reconstruct dip
10.36	Culvert. Clean and brush inlet and outlet
10.43	Construct dip. Leadout to left side of road

# Reconstruction Plans

Road Number: 34

Backslope 0.75:1

Road Name: **Jouberts**

Fillslope 1.5:1

Minimum Travel Way = 14'

Mile Post	Description of work
10.45	Maintain dip
10.49	Reconstruct dip
10.52	Culvert. Clean and brush inlet and outlet
10.55	Culvert. Clean and brush inlet and outlet
10.56	Construct dip
10.61	Maintain dip, ensure overside drain is clear
10.7	Culvert. Clean and brush inlet and outlet
10.83	34-18 spur right. Continue left
10.85	Culvert. Clean and brush inlet and outlet
10.9	Culvert. Clean and brush inlet and outlet
11.02	Reconstruct dip
11.11	Maintain dip
11.23	Maintain dip. Ensure overside drain is clear
11.28	Culvert. Clean and brush inlet and outlet
11.3	Reconstruct dip
11.39	Maintain dip
11.4	Culvert. Clean and brush inlet and outlet
11.49	Maintain dip
11.73	Culvert. Clean and brush inlet and outlet
11.75	Reconstruct dip. Ensure overside drain clear
11.78	Culvert. Clean and brush inlet and outlet
11.79	Reconstruct dip, ensure overside drain is clear
11.91	Culvert. Clean and brush inlet and outlet
11.96	Culvert. Clean and brush inlet and outlet
12.06	Maintain dip
12.08	Culvert. Clean and brush inlet and outlet
12.06	End reconstruction at intersection with 293-18-05 road. End blading shaping and brushing. End logout.

## Reconstruction Plans

Road Number: 34

Backslope 0.75:1

Road Name: Jouberts

Fillslope 1.5:1

Minimum Travel Way = 14'

### Notes:

- 1) Maintain 2-4% outslope where practical.
- 2) Roadside clearing limits shall be 4 feet beyond the traveled way. The minimum clearing width shall be 22 feet and the maximum shall be 32 feet. Clearing shall include trees up to 6" dbh. Clearing limits for leadoff ditches are shown on the typical drawings.





# Reconstruction Plans

Road Number: 34-02-01

Backslope 0.75:1

Road Name: **Pourier Creek Spur**

Fillslope 1.5:1

Minimum Travel Way = 14'

<u>Mile Post</u>	<u>Description of work</u>
0.0	Begin composite road reconstruction using 299 specification at intersection with 34rd. Reconstruct all existing drainage features to include rolling dips, ditches, waterbars and culvert basins.
0.01	Construct earthen barrier at completion of project activities at location of previously existing barrier.
0.20	End composite reconstruction.

Notes:

- 1) Maintain 2-4% outslope where practical.
- 2) Roadside clearing limits shall be 4 feet beyond the traveled way. The minimum clearing width shall be 22 feet and the maximum shall be 32 feet. Clearing shall include trees up to 6" dbh. Clearing limits for leadoff ditches are shown on the typical drawings.

# Reconstruction Plans

Road Number: 34-03

Backslope 0.75:1

Road Name: **Pourier Creek Spur**

Fillslope 1.5:1

Minimum Travel Way = 14'

<u>Mile Post</u>	<u>Description of work</u>
<b>0</b>	Begin composite road reconstruction at intersection with 34rd. Begin blading and shaping. Begin clearing and grubbing as necessary to obtain 14ft road width, Begin brushing both sides of roadway. Logout approx 30 trees per mile.
<b>0.01</b>	Culvert. Clean and brush inlet and outlet
<b>0.15</b>	Reconstruct dip
<b>0.19</b>	Reconstruct dip
<b>0.21</b>	Reconstruct dip
<b>0.24</b>	Reconstruct dip
<b>0.28</b>	Reconstruct dip
<b>0.31</b>	Reconstruct dip
<b>0.34</b>	Culvert. Clean and brush inlet and outlet. Begin reconstructing ditch, right.
<b>0.36</b>	End ditch reconstruction
<b>0.37</b>	Reconstruct dip
<b>0.41</b>	Reconstruct dip
<b>0.46</b>	Reconstruct dip
<b>0.46</b>	Spur left. Continue right. Continue composite road reconstruction using 299 spec.
1.80	End composite road reconstruction at intersection with 34-01 road.

Notes:

- 1) Maintain 2-4% outslope where practical.
- 2) Roadside clearing limits shall be 4 feet beyond the traveled way. The minimum clearing width shall be 22 feet and the maximum shall be 32 feet. Clearing shall include trees up to 6" dbh. Clearing limits for leadoff ditches are shown on the typical drawings.

## Reconstruction Plans

Road Number: 34-04

Backslope 0.75:1

Road Name: **Jouberts Spur**

Fillslope 1.5:1

Minimum Travel Way = 14'

<u>Mile Post</u>	<u>Description of work</u>
<b>0.0</b>	Begin reconstruction at intersection with 34rd. Begin blading shaping and brushing both sides on the roadway. Logout approx 20 trees.
<b>0.01</b>	Construct earthen barrier when project activities are completed.
<b>0.02</b>	Construct waterbar
<b>0.17</b>	Construct waterbar
<b>0.18</b>	Construct waterbar. Begin clearing and grubbing roadway.
<b>0.21</b>	Construct waterbar
<b>0.24</b>	Construct waterbar
<b>0.30</b>	End reconstruction. End blading and shaping. End brushing.

Notes:

- 1) Maintain 2-4% outslope where practical.
- 2) Roadside clearing limits shall be 4 feet beyond the traveled way. The minimum clearing width shall be 22 feet and the maximum shall be 32 feet. Clearing shall include trees up to 6" dbh. Clearing limits for leadoff ditches are shown on the typical drawings.



# Reconstruction Plans

Road Number: 34-05

Backslope 0.75:1

Road Name: **Indian Hill North**

Fillslope 1.5:1

Minimum Travel Way = 14'

<u>Mile Post</u>	<u>Description of work</u>
<b>0</b>	Begin at reconstruction at intersection with 34rd. Begin blading and shaping. Begin brushing both sides of roadway. Logout approx 15 logs per mile
<b>0.01</b>	Construct earthen barrier after completion of project activities.
<b>0.02</b>	Existing gate posts. No action needed.
<b>0.03</b>	Construct waterbar
<b>0.17</b>	Construct waterbar
<b>21</b>	Reconstruct dip
<b>0.44</b>	Reconstruct dip
<b>0.49</b>	Construct waterbar
<b>0.53</b>	Reconstruct dip
<b>0.62</b>	Reconstruct dip
<b>0.66</b>	Reconstruct dip
<b>0.72</b>	Construct waterbar
<b>0.75</b>	Place 10 Tons of 1 1/2" AB 20ft prior and over rocked dip. Intersect drainage, right.
<b>0.78</b>	Construct waterbar
<b>0.86</b>	Construct waterbar
<b>0.89</b>	Creek crossing. 14ft x 40ft. Excavate 1ft depth and place 6" angular rip rap to create LWC
<b>0.91</b>	Spur left. Continue right at Y
<b>0.94</b>	Proceed left at intersection
<b>0.98</b>	Proceed right at intersection.
<b>1</b>	Maintain approx 40ft long ditch, right.
<b>1.02</b>	Reconstruct dip
<b>1.06</b>	Reconstruct dip
<b>1.08</b>	Reconstruct dip
<b>1.12</b>	Reconstruct dip
<b>1.17</b>	Reconstruct dip
<b>1.24</b>	Reconstruct dip
<b>1.25</b>	Culvert. Clean and brush inlet and outlet. Begin reconstructing ditch, right.
<b>1.27</b>	Reconstruct dip. Culvert. Clean and brush inlet and outlet.
<b>1.29</b>	Reconstruct dip. Culvert. Clean and brush inlet and outlet.



## Reconstruction Plans

Road Number: 34-05

Backslope 0.75:1

Road Name: Indian Hill North

Fillslope 1.5:1

Minimum Travel Way = 14'

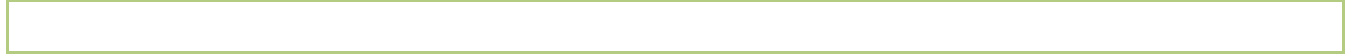

## Reconstruction Plans

Road Number: 34-05-02

Backslope 0.75:1

Road Name: **Indian Hill Spur**

Fillslope 1.5:1

Minimum Travel Way = 14'

<u>Mile Post</u>	<u>Description of work</u>
<b>0.0</b>	Begin composite road reconstruction using 299 specification at intersection with 34rd.
<b>0.01</b>	Construct earthen barrier following completion of project activities at location of previously existing barrier.
0.40	End composite reconstruction.

Notes:

- 1) Maintain 2-4% outslope where practical.
- 2) Roadside clearing limits shall be 4 feet beyond the traveled way. The minimum clearing width shall be 22 feet and the maximum shall be 32 feet. Clearing shall include trees up to 6" dbh. Clearing limits for leadoff ditches are shown on the typical drawings.

# Reconstruction Plans

Road Number: 34-06

Backslope 0.75:1

Road Name: Jouberts Spur

Fillslope 1.5:1

Minimum Travel Way = 14'

<u>Mile Post</u>	<u>Description of work</u>
<b>0.0</b>	Begin composite road reconstruction using 299 specification at intersection with 34rd.
<b>0.01</b>	Construct earthen barrier following completion of project activities at location of previously existing barrier.
<b>1.10</b>	End composite reconstruction.

Notes:

- 1) Maintain 2-4% outslope where practical.
- 2) Roadside clearing limits shall be 4 feet beyond the traveled way. The minimum clearing width shall be 22 feet and the maximum shall be 32 feet. Clearing shall include trees up to 6" dbh. Clearing limits for leadoff ditches are shown on the typical drawings.

# Reconstruction Plans

Road Number: 34-07

Backslope 0.75:1

Road Name: **Skinner**

Fillslope 1.5:1

Minimum Travel Way = 14'

<u>Mile Post</u>	<u>Description of work</u>
<b>0</b>	Begin composite road reconstruction at intersection with 34rd. Begin blading and shaping. Begin brushing both sides of roadway. Logout approx 10 trees per mile
<b>0.05</b>	Culvert. Clean and brush inlet and outlet.
<b>0.08</b>	Maintain dip
<b>0.2</b>	Construct dip into ditch, right. Reconstruct ditch right from dip along road until overside drainage is achieved, approx 90ft
<b>0.27</b>	Construct dip, leadout to left.
<b>0.32</b>	Reconstruct dip
<b>0.34</b>	Culvert. Clean and brush inlet and outlet
<b>0.4</b>	Reconstruct dip
<b>0.49</b>	Culvert. Clean and brush inlet and outlet
<b>0.54</b>	Reconstruct dip
<b>0.57</b>	Culvert. Clean and brush inlet and outlet. Begin reconstructing inside ditch.
<b>0.62</b>	End ditch reconstruction. Reconstruct dip
<b>0.69</b>	Reconstruct dip
<b>0.8</b>	Maintain dip
<b>0.89</b>	Clean overside drain, left.
<b>0.92</b>	34-07-01 left. Continue right.
<b>0.97</b>	Reconstruct dip
<b>0.99</b>	Culvert. Clean and brush inlet and outlet
<b>1.05</b>	Construct waterbar
<b>1.1</b>	Reconstruct dip
<b>1.16</b>	Construct waterbar
<b>1.21</b>	Construct waterbar
<b>1.25</b>	Construct waterbar
<b>1.29</b>	Construct waterbar
<b>1.32</b>	Culvert. Clean and brush inlet and outlet
<b>1.37</b>	Reconstruct rolling dip
<b>1.41</b>	Construct waterbar
<b>1.45</b>	Maintain dip
<b>1.53</b>	Construct waterbar



# Reconstruction Plans

Road Number: 34-08

Backslope 0.75:1

Road Name: **Upper Indian Creek**

Fillslope 1.5:1

Minimum Travel Way = 14'

<u>Mile Post</u>	<u>Description of work</u>
<b>0</b>	Begin composite road reconstruction at intersection with 34rd. Begin blading and shaping. Begin brushing both sides of roadway. Logout approximately 10 trees per mile.
<b>0.01</b>	Construct earthen barrier following completion of project activities.
<b>0.02</b>	Existing gate. No action needed
<b>0.18</b>	Construct dip
<b>0.39</b>	Construct dip
<b>0.46</b>	Culvert. Clean and brush inlet
<b>0.52</b>	Construct dip
<b>0.61</b>	Spur right, continue left.
<b>0.64</b>	Construct dip. Existing Gate, no action needed.
<b>0.67</b>	Reconstruct dip
<b>0.75</b>	Construct dip
<b>0.80</b>	Reconstruct dip
<b>0.88</b>	Reconstruct dip
<b>0.97</b>	Reconstruct dip
<b>1.05</b>	Begin reconstructing ditch in culvert basin. Approx 75ft.
<b>1.07</b>	End ditch reconstruction. Clean and brush culvert inlet and outlet
<b>1.22</b>	Reconstruct dip
<b>1.32</b>	49-27, left. Continue straight
<b>1.38</b>	Maintain dip
<b>1.39</b>	Maintain dip
<b>1.42</b>	Maintain dip
<b>1.44</b>	Maintain dip
<b>1.65</b>	Reconstruct dip
<b>1.68</b>	Reconstruct dip
<b>1.73</b>	Reconstruct dip
<b>1.87</b>	Reconstruct dip
<b>1.91</b>	Reconstruct dip





## Reconstruction Plans

Road Number: 34-08

Backslope 0.75:1

Road Name: Upper Indian Creek

Fillslope 1.5:1

Minimum Travel Way = 14'

## Reconstruction Plans

Road Number: 34-07-01

Backslope 0.75:1

Road Name: **Skinner Spur**

Fillslope 1.5:1

Minimum Travel Way = 14'

<u>Mile Post</u>	<u>Description of work</u>
<b>0.0</b>	Begin composite road reconstruction using 299 specification at intersection with 34rd.
<b>0.01</b>	Construct earthen barrier following completion of project activities at location of previously existing barrier.
0.20	End composite reconstruction.

Notes:

- 1) Maintain 2-4% outslope where practical.
- 2) Roadside clearing limits shall be 4 feet beyond the traveled way. The minimum clearing width shall be 22 feet and the maximum shall be 32 feet. Clearing shall include trees up to 6" dbh. Clearing limits for leadoff ditches are shown on the typical drawings.

## Reconstruction Plans

Road Number: 34-09

Backslope 0.75:1

Road Name: **Little Humbug**

Fillslope 1.5:1

Minimum Travel Way = 14'

<u>Mile Post</u>	<u>Description of work</u>
<b>0.0</b>	Begin composite road reconstruction using 299 specification at intersection with 34rd.
<b>0.01</b>	Construct earthen barrier following completion of project activities at location of previously existing barrier.
0.30	End composite reconstruction.

Notes:

- 1) Maintain 2-4% outslope where practical.
- 2) Roadside clearing limits shall be 4 feet beyond the traveled way. The minimum clearing width shall be 22 feet and the maximum shall be 32 feet. Clearing shall include trees up to 6" dbh. Clearing limits for leadoff ditches are shown on the typical drawings.

# Reconstruction Plans

Road Number: 34-09-01

Backslope 0.75:1

Road Name: **Little Humbug Spur**

Fillslope 1.5:1

Minimum Travel Way = 14'

<u>Mile Post</u>	<u>Description of work</u>
<b>0.0</b>	Begin composite road reconstruction using 299 specification at intersection with 34rd.
<b>0.01</b>	Construct earthen barrier following completion of project activities at location of previously existing barrier.
0.46	End composite reconstruction.

Notes:

- 1) Maintain 2-4% outslope where practical.
- 2) Roadside clearing limits shall be 4 feet beyond the traveled way. The minimum clearing width shall be 22 feet and the maximum shall be 32 feet. Clearing shall include trees up to 6" dbh. Clearing limits for leadoff ditches are shown on the typical drawings.

# Reconstruction Plans

Road Number: 34-11

Backslope 0.75:1

Road Name: Jouberts Mountain House

Fillslope 1.5:1

Minimum Travel Way = 14'

<u>Mile Post</u>	<u>Description of work</u>
<b>0.0</b>	Begin composite road reconstruction using 299 specification at intersection with 34rd.
<b>0.01</b>	Construct earthen barrier following completion of project activities at location of previously existing barrier.
0.30	End composite reconstruction.

Notes:

- 1) Maintain 2-4% outslope where practical.
- 2) Roadside clearing limits shall be 4 feet beyond the traveled way. The minimum clearing width shall be 22 feet and the maximum shall be 32 feet. Clearing shall include trees up to 6" dbh. Clearing limits for leadoff ditches are shown on the typical drawings.

# Reconstruction Plans

Road Number: 34-13-01

Backslope 0.75:1

Road Name: **Twin Quartz Spur**

Fillslope 1.5:1

Minimum Travel Way = 14'

<u>Mile Post</u>	<u>Description of work</u>
<b>0.0</b>	Begin composite road reconstruction using 299 specification at intersection with 34rd.
<b>0.01</b>	Construct earthen barrier following completion of project activities at location of previously existing barrier.
0.24	End composite reconstruction.

Notes:

- 1) Maintain 2-4% outslope where practical.
- 2) Roadside clearing limits shall be 4 feet beyond the traveled way. The minimum clearing width shall be 22 feet and the maximum shall be 32 feet. Clearing shall include trees up to 6" dbh. Clearing limits for leadoff ditches are shown on the typical drawings.

# WATER BAR DETAIL

For Use on Open Roads  
110 SCALE

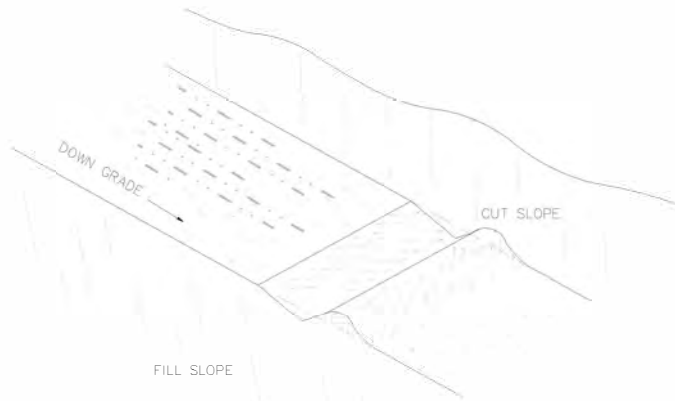

PERSPECTIVE VIEW

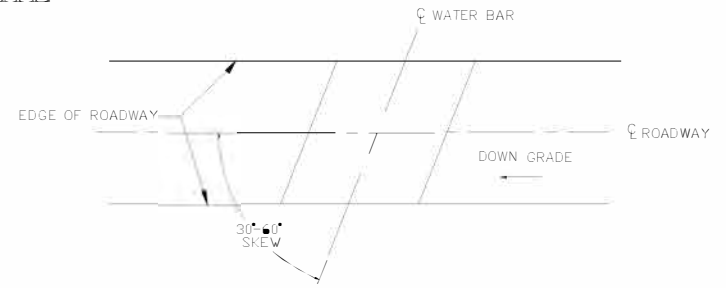

PLAN VIEW

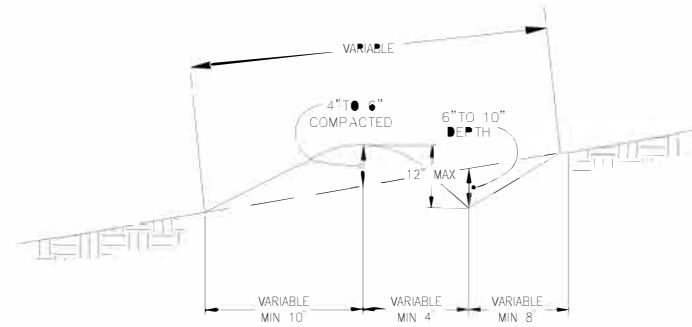

PROFILE VIEW

NOTES:

1. ALL WATER BARS SHALL BEGIN AT THE INTERSECTION OF THE ROAD BED AND CUT SLOPE AND RUN ACROSS THE ENTIRE WIDTH OF ROADBED.
2. ALL WATER BARS SHALL HAVE FREE FLOWING OUTLETS.
3. WHEN STAKES ARE USED, THEY SHALL DESIGNATE THE OUTLET LOCATION.
4. WATER BARS SHALL BE SKEWED AS SHOWN IN PLAN VIEW.

WATER BAR DETAIL		
PROJECT NAME	SHEET NUMBER	OF SHEETS
Sleighville SA	2	6



# ROLLING DIP DETAIL

110 SCALE

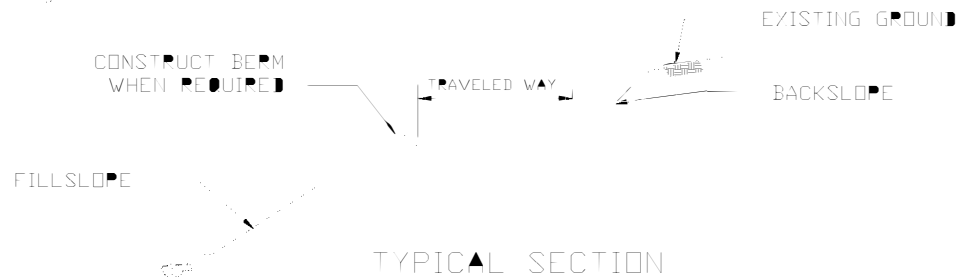
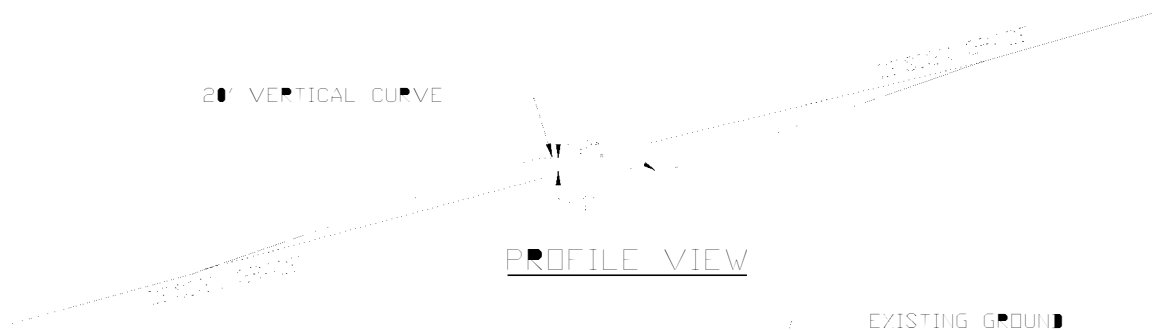
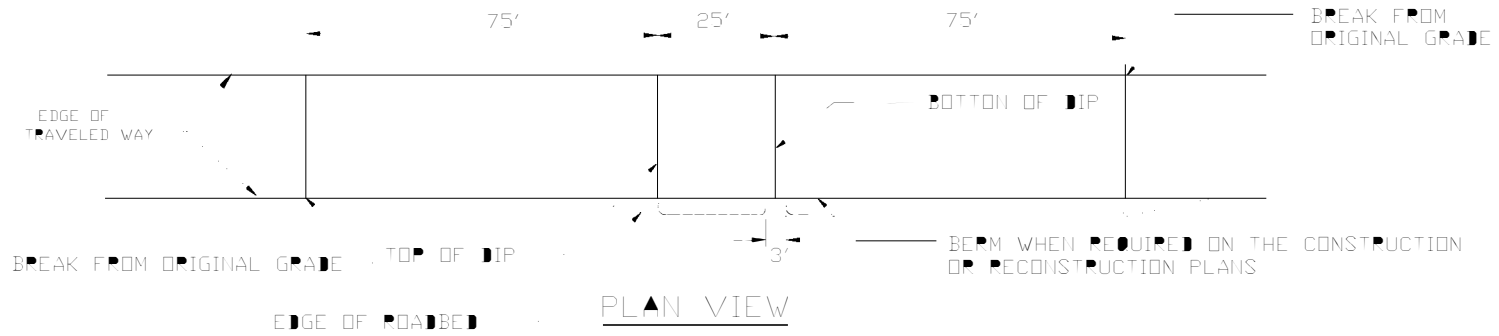

ROLLING DIP DETAIL		
PROJECT NAME	SHEET NUMBER	OF SHEETS
Sleighville SA	3	6

# ROCKED DIP DETAIL

NO SCALE

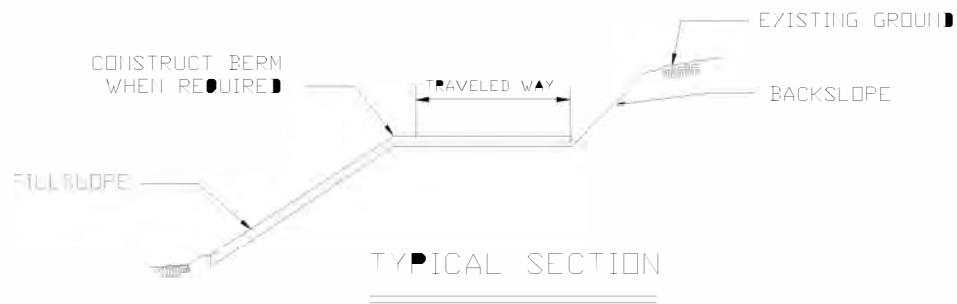
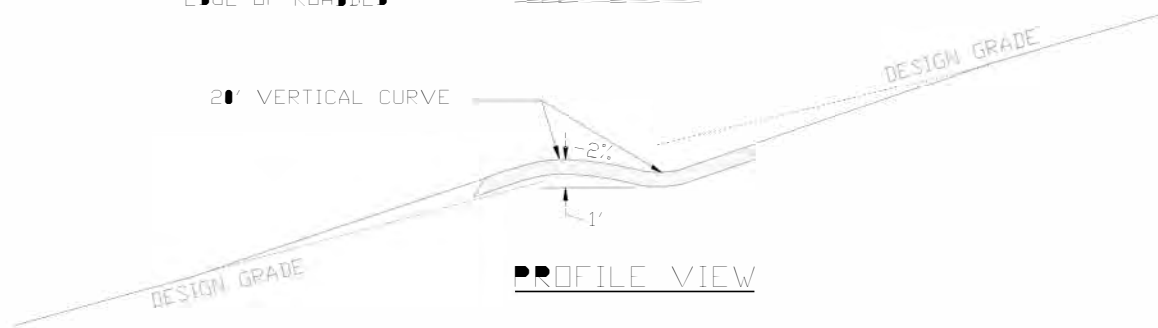
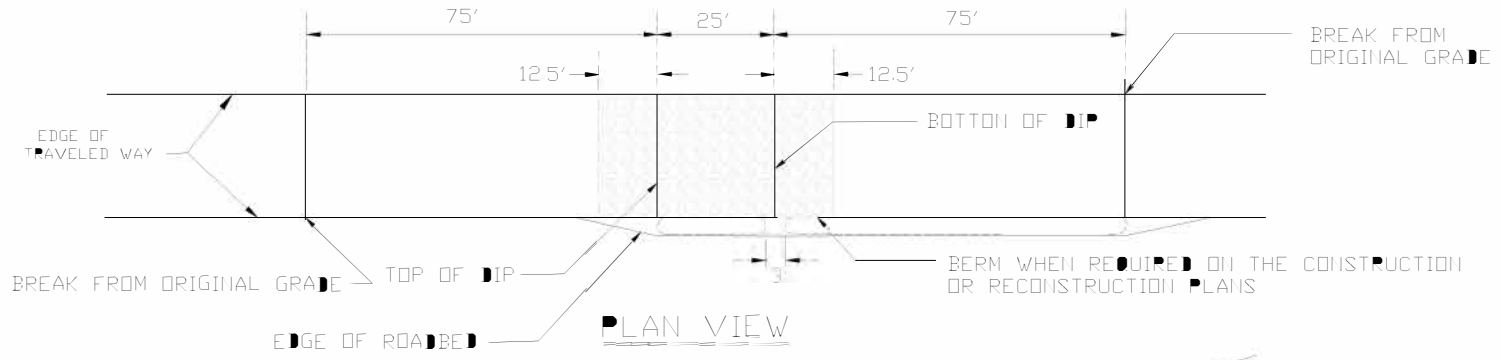

ROCKED DIP DETAIL		
PROJECT NAME	SHEET NUMBER	OF SHEETS
Sleighville SA	4	6

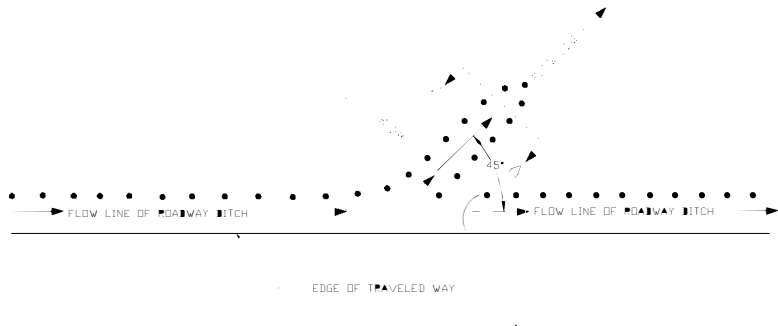

LEADOFF DITCH IN CUT-PLAIN VIEW



LEADOFF DITCH AT THE END OF A CUT-PLAIN VIEW

**CONSTRUCTION LIMITS**

TQE OF FILL —————  
 TQE OF CUT •••••

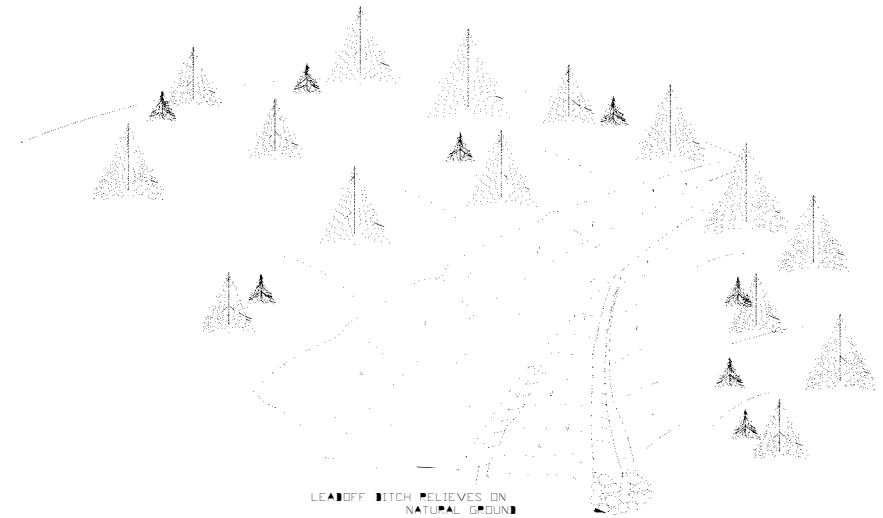
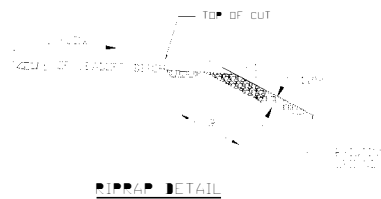

SCHEMATIC OF LEADOFF DITCH

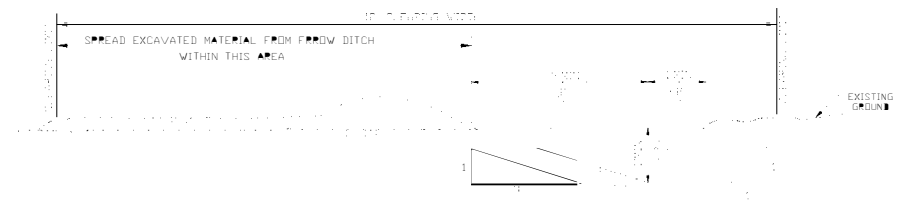

LEADOFF DITCH SECTION A-A

**NOTES:**

- ◆ PROPOSED LEADOFF DITCHES SHALL BE CONSTRUCTED ON THE EXISTING NATURAL GROUND UNLESS OTHERWISE SPECIFIED. ALL EXCAVATIONS SHALL BE PROTECTED TO THE DEGREE AND WITH THE SAME CARE AS IF THEY WERE TO BE USED FOR THE PURPOSES OF OTHER CONSTRUCTION PROJECTS.
- ◆ THESE DIMENSIONS MAY BE LARGER THAN SHOWN IF NECESSARY TO DRAIN PROPERLY.
- ◆ THE LEADOFF DITCH SHALL BE CONSTRUCTED TO A DEPTH WHICH IS AT LEAST 18 INCHES BELOW THE FINISHED ROAD SURFACE TO ALLOW FOR A 12 INCH DEPTH OF FINISHED ROAD SURFACE.

**LEADOFF DITCH DETAIL**

PROJECT NAME	SHEET NUMBER	OF SHEETS
Steighville SA	6	6

**ROAD SUBJECT  
TO  
HR. DELAY**

FG 20-5-36  
FG 20-5-48  
24" x 12"



M4-10L  
30" x 9"  
RIGHT OR LEFT

**END  
ROAD WORK**

G20-2  
36" x 14"

**ROAD  
MACHINERY  
AHEAD**

W21-3  
30" x 30" MIN.  
36" x 36" TYPICAL

**DETOUR  
AHEAD**

W20-2  
30" x 30" MIN.  
36" x 36" TYPICAL

**DETOUR  
500 FT**

W20-2  
30" x 30" MIN.  
36" x 36" TYPICAL

**ROAD  
WORK  
AHEAD**

W21-2  
30" x 30" MIN.  
36" x 36" TYPICAL



W21-1  
30" x 30" MIN.  
36" x 36" TYPICAL



W20-7  
30" x 30" MIN.  
36" x 36" TYPICAL

**ROAD  
WORK  
AHEAD**

W20-1  
30" x 30" MIN.  
36" x 36" TYPICAL

**ROUGH  
ROAD**

W8-8  
30" x 30" MIN.  
36" x 36" TYPICAL

**ONE LANE  
BRIDGE**

W5-3  
30" x 30" MIN.  
36" x 36" TYPICAL

**TRUCK  
CROSSING**

W8-6  
30" x 30" MIN.  
36" x 36" TYPICAL

**LOOSE  
GRAVEL**

W8-7  
30" x 30" MIN.  
36" x 36" TYPICAL

**GENERAL NOTES:**

1. SIGNS, SIGN SUPPORTS AND CHANNELIZING DEVICES SHALL BE IN ACCORDANCE WITH MINIMUM SPECIFICATIONS SET FORTH ON UNIFORM TRAFFIC CONTROL DEVICES FOR STREETS AND HIGHWAYS, LATEST EDITION.
2. SIGNS SHALL BE MADE FROM SUITABLE MATERIALS WHICH ARE IN ACCORDANCE WITH ALL STATE AND FEDERAL SPECIFICATIONS.
3. ALL CONSTRUCTION SIGNS SHALL BE BLACK ON ORANGE.
4. SIGNS THAT ARE INTENDED TO BE USED DURING AN HOUR OF DARKNESS OR LONGER THAN THREE DAYS IN THE SAME LOCATION SHALL BE EITHER RETROREFLECTIVE OR ILLUMINATED.
5. SIGN SUBSTRATE MAY BE WOOD, METAL, POLYPLATE, FABRIC OR OTHER APPROVED MATERIAL.
6. SIGNS SHALL BE LOCATED WHERE THEY WILL BE CONSPICUOUSLY VISIBLE DAY AND NIGHT ON THE RIGHT HAND SIDE OF APPROACHING TRAFFIC. THEY SHALL BE FACING TRAFFIC AND LOCATED WHERE THEY CAN BE SEEN AT ALL TIMES BY APPROACHING DRIVERS.
7. WHEN A SIGN IS REQUIRED FOR AN EXTENDED PERIOD, IT SHALL BE FASTENED TO 4 X 4 POSTS WITH 2-3/8" CARRIAGE BOLTS. PORTABLE CRASHWORTHY SUPPORTS ARE PERMITTED FOR SHORT PERIODS PROVIDED THE CONSTRUCTION IS SUCH THAT WIND OR OTHER AGENTS CANNOT READILY UPSET THE SIGN.
8. ADVANCE WARNING SIGNS OF CONSTRUCTION ACTIVITIES SHOULD BE LOCATED BETWEEN 500 AND 1500 FEET IN ADVANCE OF CONSTRUCTION, DEPENDING UPON THE PREVAILING SPEED ON THE ROAD.
9. OTHER SIGNS, NOT SHOWN, THAT BETTER DESCRIBE THE CONSTRUCTION ACTIVITY MAY BE USED PROVIDED THEY ARE IN CONFORMANCE WITH MUTCD STANDARDS AND COMMONLY USED BY OTHER AGENCIES.
10. SELECTION AND PLACEMENT OF ALL SIGNS SHALL BE SUBJECT TO APPROVAL OF THE ENGINEER.
11. LIGHTING DEVICES SUCH AS FLASHERS, TORCHES, LANTERNS AND ELECTRIC LIGHTS SHALL BE PLACED AND MAINTAINED FROM SUNSET TO SUNRISE AT ALL POINTS OF HAZARD AND AT ALL SIGNS INDICATING CAUTION.
12. DIAMOND WARNING SIGNS SHALL BE 30" X 30" OR LARGER FOR LOW VOLUME ROADS. A LOW VOLUME ROAD IS DEFINED AS HAVING AN AVERAGE OF LESS THAN 400 VEHICLES PER DAY AND AN 85TH PERCENTILE SPEED OF LESS THAN 35 MILES PER HOUR.
13. DIAMOND WARNING SIGNS FOR CONVENTIONAL ROADS SHALL BE 36" X 36" OR LARGER.
14. BARRICADES SHALL BE CRASHWORTHY.
15. THE SIDES OF BARRICADES FACING TRAFFIC SHALL HAVE RETROREFLECTIVE RAIL FACES.
16. STRIPES ON BARRICADE RAILS SHALL BE ALTERNATING ORANGE AND WHITE.

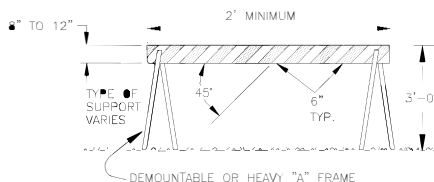

**TYPE I BARRICADE**

W20-1

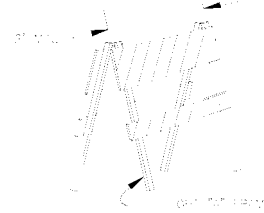

**TYPE II BARRICADE**

FR 11-2b-20 III.

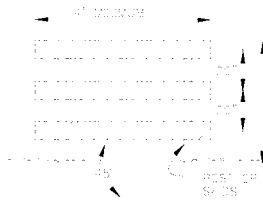

**TYPE III BARRICADE**

CONSTRUCTION SIGNS		
PROJECT NAME	SHEET NUMBER	OF SHEETS
Sleighville SA	5	6

# Sleighville SA

## Forest Service Supplemental Specifications

### Table of Contents

Preface.....	3
101 - Terms, Format, and Definitions.....	3
101.01 Meaning of Terms.....	3
101.03 Abbreviations.....	3
101.04 Definitions.....	4
102 - Bid, Award, and Execution of Contract .....	7
Delete Section 102.....	7
103 - Scope of Work.....	7
Delete Subsections 103.02, 103.03, 103.04, 103.05.....	7
104 - Control of Work .....	7
Delete Subsections 104.01, 104.02, 104.04.....	7
104.06 Use of Roads by Contractor.....	7
106 - Acceptance of Work.....	7
106.01 Conformity with Contract Requirements.....	7
106.02 Visual Inspection.....	9
107 - Legal Relations and Responsibility to the Public .....	9
Delete Subsection 107.05.....	9
108 - Prosecution and Progress .....	9
Delete Section 108.....	9
109 - Measurement and Payment .....	9
Delete Subsections 109.06, 109.07, 109.08, 109.09.....	10
109.01 Measurement of Work.....	10
109.02 Measurement Terms and Definitions.....	11
155 - Schedules for Construction Contracts .....	11
Delete Section 155.....	11
204 - Excavation and Embankment .....	11
Section 204. — Excavation and Embankment .....	11
299 – Composite Road Reconstruction.....	24
299 – Composite Road Reconstruction.....	24
299.01 Description of Work.....	24
299.02 Clearing and Disposal.....	24
299.04 Excavation and Embankment.....	25

# Sleighville SA

## Forest Service Supplemental Specifications

299.05 Method of Measurement. ....	26
299.06 Basis of Payment.....	26
302 - Minor Crushed Aggregate.....	27
302.04 Placing Crushed Aggregate. ....	27
302.05 Compacting and Finishing Crushed Aggregate .....	27
703 - Aggregate.....	27
703.05 Subbase, Base, Surface Course, and Screened Aggregate.....	27

# Sleighville SA

## Forest Service Supplemental Specifications

### Preface

Preface\_wo\_06\_03\_2020

**Delete all but the first paragraph and add the following:**

The Forest Service, US Department of Agriculture has adopted FP-14 for construction of National Forest System Roads.

## 101 - Terms, Format, and Definitions

101.01\_National\_11\_9\_2016

**Add the following paragraph to Subsection 101.01:**

### 101.01 Meaning of Terms.

Delete all references to the TAR (Transportation Acquisition Regulations) in the specifications.

101.03\_National\_11\_9\_2016

**Add the following to Subsection 101.03:**

### 101.03 Abbreviations.

**(a) Acronyms.**

AGAR — Agriculture Acquisition Regulations  
AFPA — American Forest and Paper Association  
FSAR — Forest Service Acquisition Regulations  
MSHA — Mine Safety and Health Administration  
NESC — National Electrical Safety Code  
WCLIB — West Coast Lumber Inspection Bureau

**(f) Miscellaneous unit abbreviations.**

MP	—	milepost	location
ppm	—	parts per million	volume
STA		station	location

101.04\_National\_1\_22\_2020

**Make the following changes to Subsection 101.04:**

# Sleighville SA

## Forest Service Supplemental Specifications

### 101.04 Definitions.

#### Delete these definitions and replace the following:

**Bid Schedule** — The Schedule of Items.

**Bridge** — A structure, including supports, erected over a depression or an obstruction such as water along a road, a trail, or a railway and having a deck for carrying traffic or other loads.

**Contractor** — The individual or legal entity contracting with the Government for performance of prescribed work. In a timber sale contract, the contractor is the “Purchaser”.

**Culvert** — Any structure with a bottom, regardless of fill depth, depth of invert burial, or presence of horizontal driving surface, or any bottomless (natural channel) structure with footings that will not have wheel loads in direct contact with the top of the structure.

**Drawings** — (Public Works Contracts) Design sheets or fabrication, erection, or construction details submitted to the CO by the Contractor according to FAR Clause 52.236-21 Specifications and Drawings for Construction. Also refers to submissions and submittals.

**Notice to Proceed** — (Public Works Contracts) Written notice to the Contractor to begin the contract work.

**Right-of-Way** — A general term denoting (1) the privilege to pass over land in some particular line (including easement, lease, permit, or license to occupy, use, or traverse public or private lands), or (2) Real property necessary for the project, including roadway, buffer areas, access, and drainage areas.

**Solicitation**—(Public Works Contracts) The complete assembly of documents (whether attached or incorporated by reference) furnished to prospective bidders.

#### Add the following definitions:

**Adjustment in Contract Price** — “Equitable adjustment,” as used in the Federal Acquisition Regulations, or “construction cost adjustment,” as used in the Timber Sale Contract, as applicable.

**Change** — “Change” means “change order” as used in the Federal Acquisition Regulations, or “design change” as used in the Timber Sale Contract.

**Forest Service** — The United States of America, acting through the Forest Service, U.S. Department of Agriculture.

**Neat Line** — A line defining the proposed or specified limits of an excavation or structure.

**Pioneer Road** — Temporary construction access built along the route of the project.

**Purchaser** — The individual, partnership, joint venture, or corporation contracting with the Government under the terms of a Timber Sale Contract and acting independently or through agents, employees, or subcontractors.

**Protected Streamcourse** — A drainage shown on the plans or timber sale area map that requires designated mitigation measures.

**Road Order** — An order affecting and controlling traffic on roads under Forest Service jurisdiction. Road Orders are issued by a designated Forest Officer under the authorities of 36 CFR, part 260.



# Sleighville SA

## Forest Service Supplemental Specifications

**Shop Drawings** — (Timber and Stewardship Contracts) Referred to as “Drawings” in FP-14, include drawings, diagrams, layouts, schematics, descriptive literature, illustrations, lists or tables, performance and test data, and similar materials furnished by Purchaser to explain in detail specific portions of the work required by the contract.

**Utilization Standards** —

The minimum size and percent soundness of trees described in Public Works contract specifications or Timber Sale and IRTC contract provisions to determine merchantable timber.

**Add Figure 101-1—Illustration of road structure terms:**

# Sleighville SA

## Forest Service Supplemental Specifications

Figure 101-1—Illustration of road structure terms.

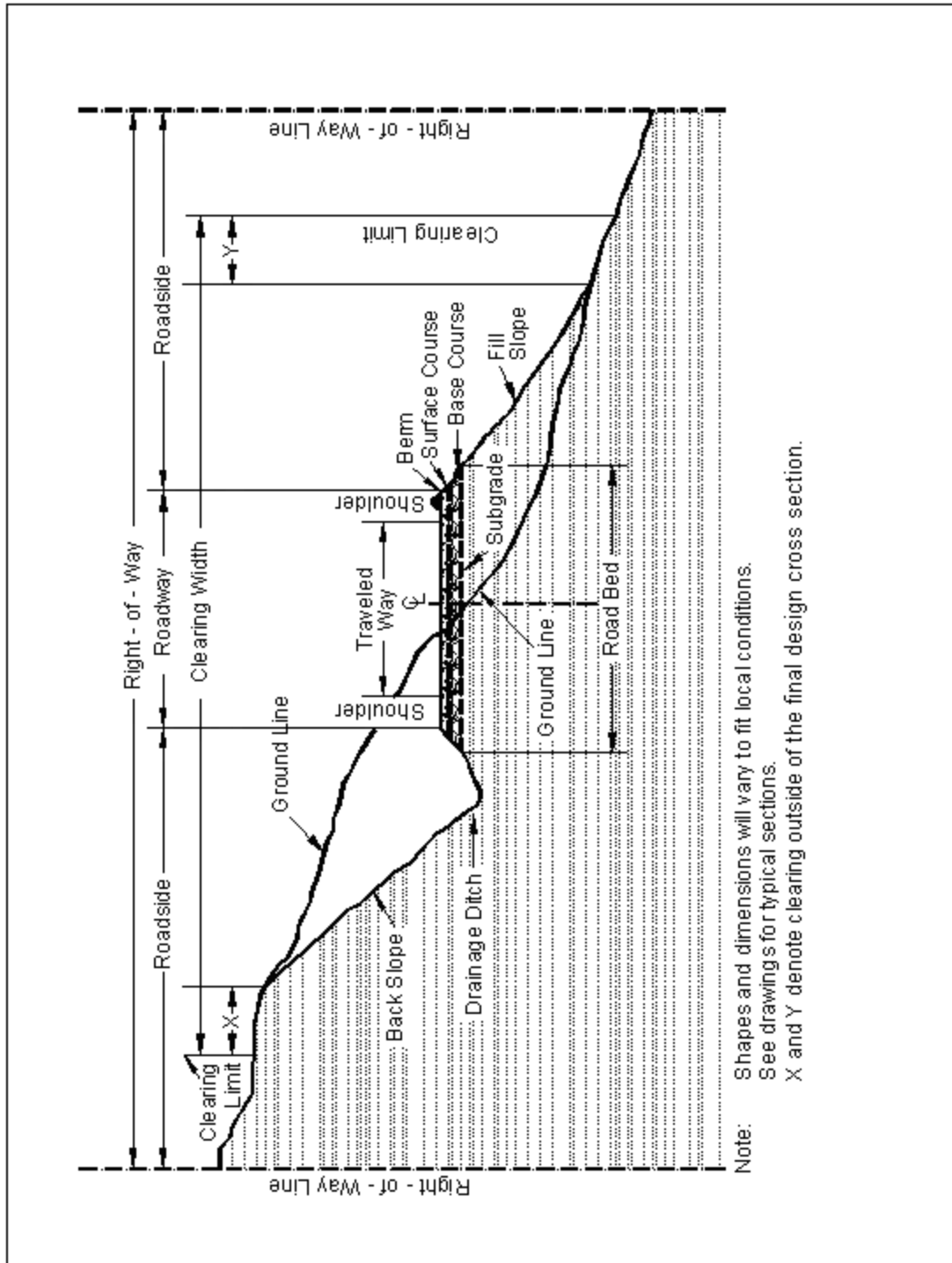

# Sleighville SA

## Forest Service Supplemental Specifications

### 102 - Bid, Award, and Execution of Contract

102.00\_National\_11\_9\_2016

**Delete Section 102 in its entirety.**

Delete Section 102.

### 103 - Scope of Work

103.00\_National\_11\_9\_2016

**Delete all of Section 103 except Subsection 103.01 Intent of Contract.**

Delete Subsections 103.02, 103.03, 103.04, 103.05.

### 104 - Control of Work

104.00\_National\_11\_9\_2016

**Delete Subsections 104.01, 104.02, and 104.04.**

Delete Subsections 104.01, 104.02, 104.04.

104.06\_National\_11\_9\_2016

**Add the following to Subsection 104.06:**

104.06 Use of Roads by Contractor.

The Contractor is authorized to use roads under the jurisdiction of the Forest Service for all activities necessary to complete this contract, subject to the limitations and authorizations designated in the Road Order(s) or described in the contract, when such use will not damage the roads or national forest resources, and when traffic can be accommodated safely.

### 106 - Acceptance of Work

106.01\_National\_7\_18\_2017

**Delete Subsection 106.01 and replace with the following:**

106.01 Conformity with Contract Requirements.

Follow the requirements of FAR Clause 52.246-12 Inspection of Construction.

References to standard test methods of AASHTO, ASTM, GSA, and other recognized standard authorities refer to the methods in effect on the date of solicitation for bids.

Perform all work to the lines, grades, cross-sections, dimensions, and processes or material requirements shown on the plans or specified in the contract.

# Sleighville SA

## Forest Service Supplemental Specifications

Incorporate manufactured materials into the work according to the manufacturer's recommendations or to these specifications, whichever is more strict.

Plan dimensions and contract specification values are the values to be strived for and complied with as the design values from which any deviations are allowed. Perform work and provide material that is uniform in character and reasonably close to the prescribed value or within the specified tolerance range. The purpose of a tolerance range is to accommodate occasional minor variations from the median zone that are unavoidable for practical reasons.

When standard manufactured items are specified (such as fence, wire, plates, rolled shapes, pipe conduits, etc., that are identified by gauge, unit mass, section dimensions, etc.), the identification will be considered to be nominal masses or dimensions. Unless specific contract tolerances are noted, established manufacturing tolerances will be accepted.

The Government may inspect, sample, or test all work at any time before final acceptance of the project. When the Government tests work, copies of test reports are furnished to the Contractor upon request. Government tests may or may not be performed at the work site. If Contractor testing and inspection is verified by the Government, the Contractor's results may be used by the Government to evaluate work for acceptance. Do not rely on the availability of Government test results for process control.

Acceptable work conforming to the contract will be paid for at the contract unit bid price. Four methods of determining conformity and accepting work are described in Subsections 106.02 to 106.05 inclusive. The primary method of acceptance is specified in each Section of work. However, work may be rejected at any time it is found by any of the methods not to comply with the contract.

Remove, repair, or replace work that does not conform to the contract, or to prevailing industry standards where no specific contract requirements are noted. Removing, repairing, or replacing work; providing temporary traffic control; and any other related work to accomplish conformity will be at no cost to the Government.

**(a) Disputing Government test results.** If the accuracy of Government test results is disputed, promptly inform the CO. If the dispute is unresolved after reasonable steps are taken to resolve the dispute, further evaluation may be obtained by written request. Include a narrative describing the dispute and a proposed resolution protocol that addresses the following:

1. Sampling method;
2. Number of samples;
3. Sample transport;
4. Test procedures;
5. Testing laboratories;
6. Reporting;
7. Estimated time and costs; and
8. Validation process.

If the evaluation requires additional sampling or testing be performed, mutually agree with the Government on witnessing procedures and on sampling and testing by a third party laboratory. Use a third party laboratory accredited by the AASHTO accreditation program. Provide proof of the laboratory's accreditation for the test procedures to be used. Do not use the same laboratory that produced the disputed Government test results or that produced the test results used as a basis for the dispute.

# Sleighville SA

## Forest Service Supplemental Specifications

The CO will review the proposed resolution protocol and may modify it before final approval and execution.

The Government will use the approved resolution protocol test results to determine the validity of the disputed testing. If the Government test results are validated, the Contractor will be responsible for all costs associated with developing and performing the resolution protocol. If the Government test results are not validated, the Government will be responsible for all costs associated with developing and performing the resolution protocol. If the validity of the Government test results cannot be determined, the Contractor and Government will equally share all costs associated with developing and carrying out the resolution protocol.

**(b) Alternatives to removing and replacing non-conforming work.** As an alternative to removal and replacement, the Contractor may submit a written request to:

1. Have the work accepted at a reduced price; or
2. Be given permission to perform corrective measures to bring the work into conformity.

The request must contain supporting rationale and documentation. Include references or data justifying the proposal based on an evaluation of test results, effect on service life, value of material or work, quality, aesthetics, and other tangible engineering basis. The CO will determine disposition of the nonconforming work.

106.02\_National\_11\_9\_2016

**Delete Subsection 106.02 and replace with the following:**

106.02 Visual Inspection.

Acceptance is based on visual inspection of the work for compliance with the specific contract requirements. Use prevailing industry standards in the absence of specific contract requirements or tolerances.

## 107 - Legal Relations and Responsibility to the Public

107.05\_National\_7\_18\_2017

**Delete Subsection 107.05.**

Delete Subsection 107.05.

## 108 - Prosecution and Progress

108.00\_National\_11\_9\_2016

**Delete Section 108 in its entirety.**

Delete Section 108.

## 109 - Measurement and Payment

109.00\_National\_11\_9\_2016

# Sleighville SA

## Forest Service Supplemental Specifications

### Delete Subsections 109.06, 109.07, 109.08, and 109.09:

Delete Subsections 109.06, 109.07, 109.08, 109.09.

109.01\_National\_2\_22\_2019

### Delete the third paragraph and Table 109-1 of Subsection 109.01 and replace with the following:

#### 109.01 Measurement of Work.

Take measurements as described in Subsection 109.02 unless otherwise modified by the Measurement Subsection of the section controlling the work being performed. Table 109-1 indicates the accuracy required for quantities of the various pay units used in the Schedule of Items. Use this guide to determine the decimal placement in the final payment.

**Table 109-1**

**Decimal Accuracy of Quantities for Final Payment**

Pay Item	Level of Precision
Linear Foot	1
Exception--Timber, Steel, and concrete Piles	0.1
Station	0.1
Mile	0.01
Square Foot	0.1
Square Yard	0.1
Each	1
Acre	0.01
Gallon	1
M-Gals.	0.1
Cubic Yard	1
Exception--Structure Excavation; Sheathing Materials; Bedding, Bed Course, and Backfill Materials; Gabions;	0.1
Exception--Concrete; Masonry	0.01
Pound	1
Ton	0.1
Exception--Calcium Chloride; Sodium Chloride; Hydrated Lime; Bituminous Materials; Pavements; Bed Course Materials	0.01
Hour	0.1
MFBM	0.01
Station Yard	1
Cubic Yard Mile	1
Ton Mile	1

# Sleighville SA

## Forest Service Supplemental Specifications

109.02\_National\_11\_9\_2016

### Add the following sentence to Subsection 109.02(b):

#### 109.02 Measurement Terms and Definitions.

##### **(b) Contract quantity.**

Contract quantities will be adjusted only when there are errors in the original design of 15% or more.

## 155 - Schedules for Construction Contracts

155.00\_National\_11\_9\_2016

### Delete Section 155 in its entirety.

Delete Section 155.

## 204 - Excavation and Embankment

204.00\_National\_10\_15\_2020

### Delete Section 204 in its entirety and replace with the following.

#### Section 204. — Excavation and Embankment

##### **Description**

**204.01** This work consists of excavating material and constructing embankments. This work also includes furnishing, hauling, stockpiling, placing, disposing, sloping, shaping, compacting, and finishing earthen and rocky material.

##### **204.02 Definitions.**

**(a) Excavation.** Excavation consists of the following:

**(1) Roadway excavation.** Material excavated from within the right-of-way or easement areas, except subexcavation covered in Subsection 204.02(a)(2) and structure excavation covered in Sections 208 and 209. Roadway excavation includes all material encountered regardless of its nature or characteristics.

**(2) Subexcavation.** Material excavated from below subgrade elevation in cut sections or from below the original ground-line in embankment sections. Subexcavation excludes the work required by Subsection 204.05 or 204.06.

**(3) Borrow excavation.** Material used for embankment construction that is obtained from outside the roadway prism. Borrow excavation includes unclassified borrow, and topping.

**(b) Embankment construction.** Embankment construction consists of placing and compacting roadway or borrow excavation. This work includes:

# Sleighville SA

## Forest Service Supplemental Specifications

- (1) Preparing foundation for embankment;
- (2) Constructing roadway embankments;
- (3) Benching for side-hill embankments;
- (4) Constructing dikes, ramps, mounds, and berms; and
- (5) Backfilling subexcavated areas, holes, pits, and other depressions.

**(c) Conserved topsoil.** Excavated material conserved from the roadway excavation and embankment foundation areas that is suitable for growth of grass, cover crops, or native vegetation.

**(d) Waste.** Excess and unsuitable roadway excavation and subexcavation that cannot be used.

### Material

**204.03** Conform to the following Subsections:

Topping	704.05
Unclassified borrow	704.06
Water	725.01(c)

### Construction Requirements

**204.04 Preparation for Roadway Excavation and Embankment Construction.** Clear the area of vegetation and obstructions according to Sections 201 and 203.

Road pioneering, slash disposal, and grubbing of stumps may proceed concurrently with excavation and embankment. Maintain drainage during pioneering operations.

**204.05 Conserved Topsoil.** When designated, conserve topsoil from roadway excavation and embankment foundation areas. Stockpile conserved topsoil in low windrows immediately beyond the rounding limits of cut and embankment slopes or in other approved locations. Separate conserved topsoil from other excavated material. When designated, place conserved topsoil on completed slopes according to Section 624.

**204.06 Roadway Excavation.** Excavate as follows:

**(a) Rock cuts.** Blast rock according to Section 205. Excavate rock cuts to 6 inches (150 millimeters) below subgrade within the roadbed limits. Backfill to subgrade with topping or other suitable material. Compact the material according to Subsection 204.11.

**(b) Earth cuts.** Scarify earth cuts to 6 inches (150 millimeters) below subgrade within the roadbed limits. Compact the scarified material according to Subsection 204.11.

**(c) Pioneer Roads.** Conduct excavation and placement operations so material to be treated under Section 201 will not be incorporated into the roadway unless specified in the slash treatment method. Maintain drainage during pioneering operations.



# Sleighville SA

## Forest Service Supplemental Specifications

Remove snow and ice in advance of the work and deposit beyond the roadway limits in a manner that will not waste material or generate sediment. Do not incorporate snow and ice into embankments. Place snow or ice in a manner to prevent resource damage.

**(d) Drainage Feature.** Drainage feature includes construction of all ditches, minor channel changes, drainage dips, catch basins, surface water deflectors, and other minor drainage structures. Compact the material according to Subsection 204.11. Excavate on a uniform grade between control points.

Do not disturb material and vegetation outside the construction limits. Retrieve material deposited outside the construction limits. Dispose of unsuitable or excess excavation material according to Subsection 204.14. Replace shortage of suitable material caused by premature disposal of roadway excavation.

Shape to drain and compact the work area to a uniform cross-section at the end of each day's operations.

**204.07 Subexcavation.** Excavate material to the required limits. Dispose of unsuitable material according to Subsection 204.14. Take cross-sections according to Section 152. Backfill subexcavated area with suitable material in horizontal layers not exceeding 12 inches (300 millimeters) in compacted thickness and compact according to Subsection 204.11. Prevent unsuitable material from mixing with suitable backfill material.

**204.08 Borrow Excavation.** Use suitable roadway excavation in embankment construction. Do not use borrow excavation when it results in excess roadway excavation. Deduct excess borrow excavation from the total borrow excavation quantity.

Obtain borrow source approval according to Subsection 105.02. Develop and restore borrow sources according to Subsections 105.03 and 105.06. Do not excavate beyond the established limits. When applicable, shape the borrow source to permit accurate measurements when excavation is complete.

**204.09 Preparing Foundation for Embankment Construction.** Prepare foundation for embankment construction as follows:

**(a) Embankment over natural ground.** Remove topsoil and break up the ground surface to a minimum depth of 6 inches (150 millimeters) by plowing or scarifying. Compact the ground surface according to Subsection 204.11.

**(b) Embankments over an existing asphalt, concrete, or gravel road surface.** Scarify gravel roads to a minimum depth of 6 inches (150 millimeters). Scarify or pulverize asphalt and concrete roads to 6 inches (150 millimeters) below the pavement. Reduce particles to a maximum size of 6 inches (150 millimeters) and produce a uniform material. Compact the surface according to Subsection 204.11.

**(c) Embankment across ground not capable of supporting equipment.** Dump successive loads of embankment material in a uniformly distributed layer to construct the lower portion of the embankment. Limit the layer thickness to the minimum depth necessary to support the equipment.

**(d) Embankment on an existing slope steeper than 1V:3H.** Cut horizontal steps in the existing slope to a sufficient width to accommodate placement and compaction operations and equipment. Step the slope as the embankment is placed and compacted in layers. Begin each step at the intersection of the original ground and the vertical cut of the previous step.

**204.10 Embankment Construction.** Incorporate only suitable roadway excavation material into the embankment. When the supply of suitable roadway excavation is exhausted, furnish unclassified borrow to complete the

# Sleighville SA

## Forest Service Supplemental Specifications

embankment. Obtain written approval before beginning construction of embankments over 6 feet (2 meters) high at subgrade centerline. Construct embankments as follows:

**(a) General.** At the end of each day's operations, shape to drain and compact the embankment surface to a uniform cross-section. Eliminate ruts and low spots that could hold water.

During all stages of construction, route and distribute hauling and leveling equipment over the width and length of each layer of material.

Compact embankment side slopes with a tamping foot roller, by walking with a dozer, or by over-building the fill and then removing excess material to the final slope line. For slopes 1V:1½H or steeper, compact the slopes as embankment construction progresses.

**(b) Embankment within the roadway prism.** Place embankment material in horizontal layers not exceeding 12 inches (300 millimeters) in compacted thickness. Incorporate oversize boulders or rock fragments into the 12-inch (300-millimeter) layers by reducing them in size or placing them individually as required below. Compact each layer according to Subsection 204.11 before placing the next layer.

Material composed predominately of boulders or rock fragments too large for 12-inch (300-millimeter) layers may be placed in layers up to 24 inches (600 millimeters) thick. Incorporate oversize boulders or rock fragments into the 24-inch (600-millimeter) layer by reducing them in size or placing individual rock fragments and boulders greater than 24 inches (600 millimeters) in diameter as follows:

- (1)** Reduce rock to less than 48 inches (1200 millimeters) in the largest dimension;
- (2)** Distribute rock within the embankment to prevent nesting;
- (3)** Place layers of embankment material around each rock to a depth not greater than that permitted above. Fill voids between rocks; and
- (4)** Compact each layer according to Subsection 204.11(a) before placing the next layer.

**(c) Embankment outside of roadway prism.** When placing embankment outside the staked roadway prism, place material in horizontal layers not exceeding 24 inches (600 millimeters) in compacted thickness. Compact each layer according to Subsection 204.11.

**204.11 Compaction.** Compact the embankment using one of the following methods as specified.

**(a) Placement Method 1.** Use AASHTO T 27 to determine the quantity of material retained on a No. 4 (4.75-millimeter) sieve. Compact as follows:

**(1) More than 80 percent retained on a No. 4 (4.75-millimeter) sieve.** Adjust the moisture content to a level suitable for compaction. Fill the interstices around rock with earth or other fine material as practical. Use compression-type rollers at speeds less than 6 feet (1.8 meters) per second and vibratory rollers at speeds less than 3 feet (1 meter) per second. Compact each layer of material full width with one of the following and until there is no visible evidence of further consolidation:

- (a)* Four roller passes of a vibratory roller having a minimum dynamic force of 40,000 pounds (180 kilonewtons) impact per vibration and a minimum frequency of 1000 vibrations per minute;
- (b)* Eight roller passes of a 20-ton (20-metric ton) compression-type roller; or

# Sleighville SA

## Forest Service Supplemental Specifications

(c) Eight roller passes of a vibratory roller having a minimum dynamic force of 30,000 pounds (130 kilonewtons) impact per vibration and a minimum frequency of 1000 vibrations per minute.

Increase the compactive effort for layers deeper than 12 inches (300 millimeters) as follows:

- For each additional 6 inches (150 millimeters) or fraction thereof, increase the number of roller passes in Subsection 204.11(a)(1)(a), by four passes; or
- For each additional 6 inches (150 millimeters) or fraction thereof, increase the number of roller passes in Subsection 204.11(a)(1)(b) and (c), by eight passes.

**(2) 50 to 80 percent retained on a No. 4 (4.75-millimeter) sieve.** Classify the material according to AASHTO M 145. Adjust the moisture content of material classified A-1 through A-5 to a moisture content suitable for compaction. Adjust the moisture content of material classified A-6 and A-7 to within 2 percent of the optimum moisture content. Use AASHTO T 99 to determine the optimum moisture content of the portion of the material passing a No. 4 (4.75-millimeter) sieve. Multiply this number by the percentage of material passing a No. 4 (4.75-millimeter) sieve, and add 2 percent to determine the optimum moisture content of the material.

Use nonvibratory rollers at speeds less than 6 feet (1.8 meters) per second and vibratory rollers at speeds less than 3 feet (1 meter) per second. Compact each layer of material full width according to Subsection 204.11(a)(1).

**(3) Less than 50 percent retained on a No. 4 (4.75-millimeter) sieve.** Classify the material according to AASHTO M 145. For material classified A-1 or A-2-4, determine the maximum density according to AASHTO T 99, Method C.

Adjust the moisture content of material classified A-1 through A-5 to a moisture content suitable for compaction. Adjust the moisture content of material classified A-6 and A-7 to within 2 percent of the optimum moisture content.

Use compression-type or vibratory rollers. Compact each layer of material full width to at least 95 percent of the maximum density. Determine the in-place density and moisture content according to AASHTO T 310 or other approved test procedures. When required, use AASHTO T 224 to correct for coarse particles.

**(b) Placement Method 2.** Adjust the moisture content of the material to a moisture content suitable for compaction. Fill the interstices around rock with earth or other fine material as practical. Operate roller compaction equipment over the full width of each layer until there is no visible evidence of further consolidation or, if when a sheepfoot roller is used, the roller “walks out” of the layer. Make at least three complete passes. Use compression-type rollers at speeds less than 6 feet (1.8 meters) per second and vibratory rollers at speeds less than 3 feet (1 meter) per second. Ensure rollers meet the following requirements:

- (1)** Steel wheeled rollers, other than vibratory, capable of exerting a force of not less than 250 pounds per inch (4.5 kilogram/millimeter) of width of the compression roll or rolls.
- (2)** Vibratory steel wheeled rollers equipped with amplitude and frequency controls with a minimum dynamic force of 30,000 pounds (130 kilonewtons) impact per vibration, specifically designed to compact the material on which it is used.

# Sleighville SA

## Forest Service Supplemental Specifications

**(3)** Pneumatic-tired rollers with smooth tread tires of equal size that will provide a uniform compacting pressure for the full width of the roller and capable of exerting a ground pressure of at least 80 psi (550 Kilopascals).

**(4)** Sheepsfoot, tamping, or grid rollers capable of exerting a force of 250 pounds per inch (4.5 kilogram/millimeter) of width of roller drum.

**(c) Placement Method 3.** Adjust the moisture content of the material to a moisture content suitable for compaction. Fill the interstices around rock with earth or other fine material as practical. Operate hauling and spreading equipment uniformly over the full width of each layer until there is no visible evidence of further consolidation. Make at least three complete passes.

**(d) Placement Method 4.** Adjust the moisture content of the material to a moisture content suitable for compaction. Fill the interstices around rock with earth or other fine material as practical. Operate hauling and spreading equipment uniformly over the full width of each layer.

**(e) Placement Method 5.** Adjust the moisture content of the material to a moisture content suitable for compaction. Compact the complete surface with a bucket of an excavator larger than 39,000 pounds (18 metric ton) Gross Vehicle Weight using a minimum of three blows. Overlap compaction by  $\frac{1}{2}$  width of bucket.

**(f) Placement Method 6.** Adjust the moisture content of the material to a moisture content suitable for compaction. Compact using an approved mechanical tamper for a minimum of three complete passes.

When compacting with rollers or hauling and spreading equipment is not practical, use approved mechanical tampers for a minimum of three complete passes.

**204.12 Drainage Features.** Slope, grade, and shape all drainage features. Remove projecting roots, stumps, rock, or similar matter. Maintain all drainage features in an open condition and without sticks, and other debris.

Form furrow ditches by plowing or using other acceptable methods to produce a continuous furrow. Place excavated material on the downhill side so the bottom of the ditch is approximately 18 inches (450 millimeters) below the crest of the loose material. Clean the ditch using a hand shovel or other suitable method. Shape to provide drainage without overflow.

**204.13 Sloping, Shaping, and Finishing.** Complete subgrade, slopes, drainage features, culverts, riprap, and other underground minor structures before placing aggregate courses. Slope, shape, and finish to the designated tolerance class as defined in Table 204-2 as follows:

**(a) Sloping.** Leave earth slopes with uniform roughened surfaces, except as described in Subsection 204.13(b), with no noticeable break as viewed from the road. Except in solid rock, round tops and bottoms of slopes including the slopes of drainage ditches. Round material overlaying solid rock to the extent practical. Scale rock slopes. Slope rounding is not required on tolerance class D through M roads.

If a slide or slipout occurs on a cut or embankment slope, remove or replace the material and repair or restore damage to the work. Bench or key the slope to stabilize the slide. Reshape the cut or embankment slope to an acceptable condition.

**(b) Stepped slopes.** Where required, construct steps on slopes of  $1\frac{1}{2}V:1H$  to  $1V:2H$ . Construct the steps approximately 18 inches (450 millimeters) high. Blend the steps into natural ground at the end of the cut. If the

# Sleighville SA

## Forest Service Supplemental Specifications

slope contains non-rippable rock outcrops, blend steps into the rock. Remove loose material found in transitional area. Except for removing large rocks that may fall, scaling stepped slopes is not required.

**(c) Shaping.** Shape the subgrade to a smooth surface and to the cross-section required. Shape slopes to gradually transition into slope adjustments without noticeable breaks. At the ends of cuts and at intersections of cuts and embankments, adjust slopes in the horizontal and vertical planes to blend into each other or into the natural ground.

**(d) Finishing.** Ensure that the subgrade is visibly moist during shaping and dressing; smooth and uniform, and shaped to conform to the typical sections. Remove material larger than 6 inches (150 millimeters) from the top 6 inches (150 millimeters) of the roadbed. Remove unsuitable material from the roadbed, and replace it with suitable material. Scarify to 6 inches (150 millimeters) below the bottom of low sections, holes, cracks, or depressions and bring back to grade with suitable material.

Maintain proper ditch drainage.

**204.14 Disposal of Unsuitable or Excess Material.** Dispose of unsuitable or excess material at designated sites or according to Subsection 203.05(a)

When there is a pay item for waste, shape and compact the waste material in its final location. Do not mix clearing or other material not subject to payment with the waste material.

**204.15 Acceptance.** See Table 204-1 for sampling, testing, and acceptance requirements.

Material for embankment and conserved topsoil will be evaluated under Subsections 106.02 and 106.04.

Excavation and embankment construction will be evaluated under Subsections 106.02 and 106.04.

Subexcavation will be evaluated under Subsections 106.02 and 106.04.

### Measurement

**204.16** Measure the Section 204 pay items listed in the bid schedule according to Subsection 109.02 and the following as applicable:

**(a) Roadway excavation.** Measure roadway excavation in its original position as follows:

**(1)** Include the following volumes in roadway excavation:

*(a)* Roadway prism excavation;

*(b)* Rock material excavated and removed from below subgrade in cut sections;

*(c)* Unsuitable material below subgrade and unsuitable material beneath embankment areas when a pay item for subexcavation is not listed in the bid schedule;

*(d)* Ditches, except furrow ditches measured under a separate pay item;

*(e)* Conserved topsoil;

*(f)* Borrow material used in the work when a pay item for borrow is not listed in the bid schedule;

*(g)* Loose scattered rocks removed and placed as required within the roadway;

# Sleighville SA

## Forest Service Supplemental Specifications

(h) Conserved material taken from pre-existing stockpiles and used in Section 204 work, except topsoil measured under 624; and

(i) Slide and slipout material not attributable to the Contractor's method of operation.

**(2)** Do not include the following in roadway excavation:

(a) Overburden and other spoil material from borrow sources;

(b) Overbreakage from the backslope in rock excavation;

(c) Water or other liquid material;

(d) Material used for purposes other than required;

(e) Roadbed material scarified in place and not removed;

(f) Material excavated when stepping cut slopes;

(g) Material excavated when rounding cut slopes;

(h) Preparing foundations for embankment construction;

(i) Material excavated when benching for embankments;

(j) Slide or slipout material attributable to the Contractor's method of operation;

(k) Conserved material taken from stockpiles constructed at the option of the Contractor;

(l) Material excavated outside the established slope limits; and

(m) Road pioneering for the convenience of the Contractor.

**(3)** When both roadway excavation and embankment construction pay items are listed in the bid schedule, measure roadway excavation only for the following:

(a) Unsuitable material below subgrade in cuts and unsuitable material beneath embankment areas when a pay item for subexcavation is not listed in the bid schedule;

(b) Slide and slipout material not attributable to the Contractor's method of operations; and

(c) Drainage ditches, channel changes, and diversion ditches.

**(b) Unclassified borrow, and topping.** When measuring by the cubic yard (cubic meter) measure in its original position. If borrow excavation is measured by the cubic yard (cubic meter) in-place, take initial cross-sections of the ground surface after stripping overburden. Upon completion of excavation and after the borrow source waste material is returned to the source, retake cross-sections before replacing the overburden. Do not measure borrow excavation until suitable roadway excavation is depleted.

**(c) Embankment construction.** Measure embankment construction in its final position. Do not make deductions from the embankment construction quantity for the volume of minor structures.

**(1)** Include the following volumes in embankment construction:

(a) Roadway embankments;

# Sleighville SA

## Forest Service Supplemental Specifications

(b) Material used to backfill subexcavated areas, holes, pits, and other depressions;

(c) Material used to restore obliterated roadbeds to original contours; and

(d) Material used for dikes, ramps, mounds, and berms.

**(2)** Do not include the following in embankment construction:

(a) Preparing foundations for embankment construction;

(b) Adjustments for subsidence or settlement of the embankment or of the foundation on which the embankment is placed; and

(c) Material used to round fill slopes.

**(d) Rounding cut slopes.** If a pay item for slope rounding is included in the bid schedule measure rounding cut slopes horizontally along the centerline of the roadway. If a pay item is not included for slope rounding is not included in the bid schedule payment will be considered indirect to roadway excavation.

**(e) Waste.** Measure waste by the cubic yard (cubic meter) in its final position. Take initial cross-sections of the ground surface after stripping over-burden. Upon completion of the waste placement, retake cross-sections before replacing overburden.

**(f) Slope scaling.** Measure slope scaling by the cubic yard (cubic meter) in the hauling vehicle.

**(g) Subexcavation.** Measure subexcavation by the cubic yard (cubic meter) in its original position.

**(h) Drainage features.** Measurement includes all excavation, embankment, shaping, and grading necessary for a completed drainage feature.

### Payment

**204.17** The accepted quantities will be paid at the contract price per unit of measurement for the Section 204 pay items listed in the bid schedule. Payment will be full compensation for the work prescribed in this Section. See Subsection 109.05.

# Sleighville SA

## Forest Service Supplemental Specifications

Table 204-1

### Sampling, Testing, and Acceptance Requirements

Material or Product (Subsection)	Type of Acceptance (Subsection)	Characteristic	Category	Test Methods Specifications	Sampling Frequency	Point of Sampling	Split Sample	Reporting Time
<b>Source</b>								
Topping (704.05)	Measured and tested for conformance (106.04 & 105)	Classification <sup>(1)</sup>	–	AASHTO M 145	1 per soil type and source of material	Processed material	Yes	Before using in work
Unclassified borrow (704.06)	"	"	–	"	"	"	"	"
<b>Production</b>								
Topping (704.05) and (204.11(a))	Measured and tested for conformance (106.04)	Moisture-density	–	T 99, Method C <sup>(2)</sup>	1 per soil type, but not less than 1 per each 13,000 yd <sup>3</sup> (10,000 m <sup>3</sup> )	Processed material	Yes	Before using in work
		Density	–	AASHTO T 310 or other approved procedures	1 per 3500 yd <sup>2</sup> (3000 m <sup>2</sup> ), but not less than 3 per layer	In-place	No	Before placement of next layer
Unclassified borrow (704.06) and (204.11(a))	"	Moisture-density	–	T 99, Method C <sup>(2)</sup>	1 per soil type, but not less than 1 per each 13,000 yd <sup>3</sup> (10,000 m <sup>3</sup> )	Processed material	Yes	Before using in work



# Sleighville SA

## Forest Service Supplemental Specifications

Table 204-1

### Sampling, Testing, and Acceptance Requirements

Material or Product (Subsection)	Type of Acceptance (Subsection)	Characteristic	Category	Test Methods Specifications	Sampling Frequency	Point of Sampling	Split Sample	Reporting Time
		Density	–	AASHTO T 310 or other approved procedures	1 per 3500 yd <sup>2</sup> (3000 m <sup>2</sup> ), but not less than 3 per layer	In-place	No	Before placement of next layer
<b>Production (continued)</b>								
Earth embankment (204.11(a))	Measured and tested for conformance (106.04)	Classification	–	AASHTO M 145	1 per soil type	Source of material	Yes	Before using in work
		Moisture-density	–	T 99, Method C <sup>(2)</sup>	1 per soil type, but not less than 1 per each 13,000 yd <sup>3</sup> (10,000 m <sup>3</sup> )	"	"	"
		Density	–	AASHTO T 310 or other approved procedures	1 per 3500 yd <sup>2</sup> (3000 m <sup>2</sup> ), but not less than 3 per layer	In-place	No	Before placement of next layer
Top of subgrade (204.11(a))	"	Density	–	AASHTO T 310 or other approved procedures	1 per 2500 yd <sup>2</sup> (2000 m <sup>2</sup> ), but not less than 3 per layer	In-place	No	Before placement of next layer
<b>Finished Product</b>								

# Sleighville SA

## Forest Service Supplemental Specifications

Table 204-1

### Sampling, Testing, and Acceptance Requirements

Material or Product (Subsection)	Type of Acceptance (Subsection)	Characteristic	Category	Test Methods Specifications	Sampling Frequency	Point of Sampling	Split Sample	Reporting Time
Roadbed (204.13)	Measured and tested for conformance (106.04)	Final line & grade	–	Field measured	Determined by the CO	Determined by the CO	No	Before placement of next layer

(1) Not required when using Government-provided source.

(2) Minimum 5 points per proctor.

# Sleighville SA

## Forest Service Supplemental Specifications

<b>Table 204-2 Construction Tolerances</b>													
<b>Location Description</b>	<b>Tolerance Class (a)</b>												
	A	B	C	D	E	F	G	H	I	J	K	L	M
Roadbed width (ft)	+0.5	+0.5	+1.0	+1.0	+1.0	+1.0	+1.5	+1.0	+2.0	+2.0	+2.0	+2.0	+2.0
Subgrade elevation (ft)	±0.1	±0.2	±0.2	±0.5	±0.5	±1.0	±1.0	±1.5	±2.0	±3.0	±2.0	±3.0	(c)
Centerline alignment (ft)	±0.2	±0.2	±0.5	±0.5	±1.0	±1.0	±1.5	±1.5	±2.0	±3.0	±3.0	±5.0	(c)
Slopes, excavation, and embankment (% slope <sup>(b)</sup> )	±3	±5	±5	±5	±5	±5	±10	±10	±10	±10	±20	±20	±20

(a) Maximum allowable deviation from construction stakes and drawings.  
 (b) Maximum allowable deviation from staked slope measured from slope stakes or hinge points.  
 (c) Unless otherwise shown the centerline alignment and subgrade elevation, as built, have no horizontal curves with a radius of less than 80 feet, and no vertical curves with a curve length of less than 80 feet when the algebraic difference in the grade change is less than 10 percent, or a curve length of less than 100 feet when the algebraic difference of the grade change is greater than or equal to 10 percent. The centerline grade is not to exceed 20 percent in 100 feet of length.

# Sleighville SA

## Forest Service Supplemental Specifications

### 299 – Composite Road Reconstruction

299\_Tahoe Forest\_5\_19\_2020

#### Add the following Section

#### 299 – Composite Road Reconstruction

##### 299.01 Description of Work.

This work shall consist of clearing and grubbing, excavation and embankment. Clearing and grubbing shall include treatment of merchantable timber, and disposal of construction slash, including all designated trees. Excavation and embankment shall include drainage excavation, shaping the roadway, including approaches, turnarounds, ditches, and drainage dips, and disposal of all excavated material. Construction of the roadway shall be in conformance with the dimensions SHOWN ON THE DRAWINGS and DESIGNATED on the ground.

##### 299.02 Clearing and Disposal.

All trees, snags, downed timber, brush and stumps within the clearing limits shall be removed and disposed of by

- (a) Decking or removing timber meeting utilization standards (merchantable timber).
- (b) Decking unmerchantable timber. Logs not meeting utilization standards that are more than 6 inches in diameter and 10 feet or more in length which are suitable for use as firewood, shall be limbed and bucked into lengths not to exceed 32 feet, and placed in stable decks free of brush and soil. Decks shall be located in areas SHOWN ON THE DRAWINGS or DESIGNATED on the ground. Material not suitable for firewood shall be treated under slash treatment methods.
- (c) Purchaser shall treat the construction slash by one or more of the following methods as SHOWN ON THE DRAWINGS:

**Method A** - Incorporation. Construction slash may be incorporated as part of the embankment provided it is distributed to avoid concentrations or matting, and is covered with a minimum of 18 inches of excavated material. Slash that cannot be incorporated shall be treated by other methods SHOWN ON THE DRAWINGS.

**Method B** - Windrowing construction slash. When slash is windrowed, it shall be placed approximately parallel to the roadway. The toe of the fill slope may catch or cover the finished windrow, must be covered with a minimum of 18" of excavated material. The windrow shall not hinder equipment during maintenance of the roadway.

**Method C** - Scattering. Construction slash shall be scattered outside the clearing limits in areas SHOWN ON THE DRAWINGS. Slash shall not be piled higher than 18" above the ground. Limbs having a diameter of between 3" and 6" shall be bucked into lengths not exceeding 6 feet. Material over 6" shall not be scattered, but shall be treated under other slash treatment methods.

# Sleighville SA

## Forest Service Supplemental Specifications

**Method D** - Piling for future disposal. Construction slash shall be piled in locations SHOWN ON THE DRAWINGS. Piles shall be free of soil and constructed with smaller slash well mixed with larger slash.

**Method E** - Piling and Burning. Construction slash shall be deposited in areas SHOWN ON THE DRAWINGS and DESIGNATED on the ground. Piles shall be constructed so that burning does not damage standing trees. If burning is incomplete, the slash remaining shall be repiled and burned until reduced to 20% or less of their original volume and no individual piece remaining shall be greater than four cubic feet in volume. These pieces shall then be scattered, buried, removed or left in place as SHOWN ON THE DRAWINGS.

**Method F** - Stump placement. Stumps shall be placed at locations SHOWN ON THE DRAWINGS or DESIGNATED IN THE FIELD, and placed on ground that is level or has been leveled in a manner that the stumps will not roll downhill. Stumps shall then be covered with excavated material a minimum of one quarter of the stump volume to prevent their dislodgement. When steep sideslopes prevent the successful placement of stumps, the designated disposal sites shall be used.

**Method G** - Bury. Construction slash may be buried within the roadway at locations SHOWN ON THE DRAWINGS, or DESIGNATED IN THE FIELD. Buried material shall be covered with a minimum of 24 inches of excavated material and shall not be buried within 25 feet of culverts. Slash that cannot be buried shall be treated by other methods SHOWN ON THE DRAWINGS.

**Method H** - Chipping. Construction slash up to at least 4 inches in diameter and longer than 3 feet shall be processed through a chipping machine. Chips shall be deposited on embankment slopes or outside the roadway to a loose depth not exceeding 6 inches. Minor amounts of chips may be permitted within the roadway if they are thoroughly mixed with soil and do not form a layer.

Chipping may also be accomplished by use of a roadside brushing machine designed for this specific type of work and capable of chipping trees to 10" diameter. The engineer shall approve in writing the type of brushing machine to be used in lieu of a chipping machine. A2500 gallon minimum water truck shall work with the brushing machine when it is in operation for fire protection.

All piles created under Methods D and E shall have a 15 foot fire break cleared between the piles and the adjacent vegetation.

Slash shall not be deposited within 25 feet of stream courses.

Branches on remaining trees or shrubs shall be trimmed to give a clear height of 14 feet above the roadbed unless otherwise SHOWN ON THE DRAWINGS. Tree limbs shall be trimmed as near flush with the trunk as practicable.

Fell all dead trees that are outside the clearing limits and that lean toward the road and are tall enough to reach the roadbed. Disposed in accordance with (a), (b), or (c).

[299.04 Excavation and Embankment.](#)

# Sleighville SA

## Forest Service Supplemental Specifications

The roadway shall be constructed to conform to the typical sections SHOWN ON THE DRAWINGS. Embankment shall be placed by side-casting, end-dumping, or layer placement, as SHOWN ON THE DRAWINGS.

Backslopes shall not be undercut.

Embankment material designated to be layer placed may be end dumped to the minimum depth needed for operation of spreading equipment. Each embankment layer shall be leveled and smoothed before placement of subsequent layers. Hauling and spreading equipment shall be operated uniformly over the full width of each layer, a minimum of three complete passes.

Suitable material shall be placed in layers no more than 12 inches thick, except when the material contains rock more than 9 inches in diameter, in which case layers may be of sufficient thickness to accommodate the material involved. No layer shall exceed 24 inches before compaction.

Rocks too large to be incorporated in the embankment shall be placed on the downhill side, outside the traveled way. Rocks shall be placed so that they will not roll or obstruct drainage. Rocks may not be placed against trees, nor hinder the use and the maintenance of the roadbed.

The location and use of borrow material, and any requirements for the removal and disposal of unsuitable or excess material, will be SHOWN ON THE DRAWINGS.

Unless otherwise SHOWN ON THE DRAWINGS, the roadbed shall be shaped to provide drainage of surface water, and finished to the standard ordinarily accomplished by a motor grader. Individual rocks within the roadbed shall not protrude over two inches above the subgrade. The road bed shall be visibly moist during shaping.

Unless otherwise SHOWN ON THE DRAWINGS, the traveled way width shall not exceed the specified dimension by more than two feet.

### 299.05 Method of Measurement.

The method of measurement will be "Contract Quantities" (CQ) in accordance with Section 109.

### 299.06 Basis of Payment.

The accepted quantities will be paid for at the Contract unit price for each pay item shown in the SCHEDULE OF ITEMS.

Payment will be made under:

<u>Pay Item</u>	<u>Pay Unit</u>
299(01) Composite Road Reconstruction . . . . .	STA
299(02) Composite Road Reconstruction . . . . .	MI
299(03) Composite Road Reconstruction . . . . .	L.S.

# Sleighville SA

## Forest Service Supplemental Specifications

### 302 - Minor Crushed Aggregate

302.04\_National\_10\_15\_2020

Delete Subsection 302.03(a) and replace with the following

**(a) Roadway aggregate.** Prepare the surface on which the aggregate course is placed according to Section 204, 209 or 303 as applicable.

Add the following to Subsection 302.04 and 302.04(a)

302.04 Placing Crushed Aggregate.

Written approval of the surface is required before placing aggregate.

**(a) Roadway aggregate.**

For pit run or grid-rolled material, furnish material smaller than the maximum size, no gradation will be required otherwise. After processing on the road, remove all oversize material from the road and dispose as directed by the CO.

302.05\_National\_10\_15\_2020

Replace the first paragraph of subsection 302.05(a) with the following:

302.05 Compacting and Finishing Crushed Aggregate

**(a) Roadway aggregate.** Unless otherwise specified compact according to method 2. Finish surface according to Subsection 301.06.

### 703 - Aggregate

703.05\_National\_5\_21\_2020

Delete 703.05 and replace with the following:

703.05 Subbase, Base, Surface Course, and Screened Aggregate.

**(a) Subbase or base aggregate.** Furnish hard, durable particles or fragments of crushed stone, crushed slag, or crushed gravel conforming the following:

(1) Gradation	Table 703-2
(2) Liquid limit, AASHTO T 89	25 max.
(3) Plastic limit, AASHTO T 90	Nonplastic
(4) Los Angeles abrasion, AASHTO T 96	40% max.

# Sleighville SA

## Forest Service Supplemental Specifications

- |   |          |
|---|----------|
| (5) Sodium sulfate soundness loss (5 cycles),<br>AASHTO T 104 | 12% max. |
| (6) Durability index (coarse), AASHTO T 210                   | 35 min.  |
| (7) Durability index (fine), AASHTO T 210                     | 35 min.  |
| (8) Fractured faces, ASTM D 5821                              | 50% min. |
| (9) Free from organic matter and lumps or balls of clay       |          |

Do not use material that breaks up when alternately frozen and thawed or wetted and dried.

Obtain the aggregate gradation by crushing, screening, and blending processes as necessary. Fine aggregate, material passing the No. 4 sieve, shall consist of natural or crushed sand and fine mineral particles.

**(b) Surface course aggregate.** Furnish hard, durable particles or fragments of crushed stone, crushed slag, or crushed gravel conforming the following:

- |   |             |
|---|-------------|
| (1) Gradation   | Table 703-3 |
| (2) Liquid limit, AASHTO T 89                                   | 35 max.     |
| (3) Plastic Index, AASHTO T 90                                  |             |
| a) If the percent passing the No. 200 sieve is less than 12%    | 2 to 9      |
| b) If the percent passing the No. 200 sieve is greater than 12% | Less than 2 |
| (4) Los Angeles abrasion, AASHTO T 96                           | 40% max.    |
| (5) Sodium sulfate soundness loss (5 cycles),<br>AASHTO T 104   | 12% max.    |
| (6) Durability index (coarse), AASHTO T 210                     | 35 min.     |
| (7) Durability index (fine), AASHTO T 210                       | 35 min.     |
| (8) Fractured faces, ASTM D 5821                                | 75% min.    |
| (9) Free from organic matter and lumps or balls of clay         |             |

Do not use material that breaks up when alternately frozen and thawed or wetted and dried.

Do not furnish material that contains asbestos fibers.

Obtain the aggregate gradation by crushing, screening, and blending processes as necessary. Fine aggregate, material passing the No. 4 sieve, shall consist of natural or crushed sand and fine mineral particles.

**(c) Screened aggregate** – Furnish hard, durable particles or fragments of stone, slag, or gravel conforming the following:

- |  |              |
|--|--------------|
| (1) Gradation  | Table 703-16 |
| (2) Plastic Index, AASHTO T 90                           | Less than 9  |
| (3) Los Angeles abrasion, AASHTO T 96                    | 55% max.     |
| (4) Free from organic matter and lumps or balls of clay. |              |

Do not use material that breaks up when alternately frozen and thawed or wetted and dried.

Obtain the aggregate gradation by crushing, screening, and blending processes as necessary.



# Sleighville SA

## Forest Service Supplemental Specifications

### **Delete 703.06 and replace with the following:**

703.06 **Crushed Aggregate.** Furnish certified weed free, hard, durable particles or fragments of crushed stone or gravel conforming to the size and quality requirements for crushed aggregate material normally used locally in the construction and maintenance of highways by Federal or state agencies. Furnish crushed aggregate with a maximum size of 1 inch (25 millimeters) as determined by AASHTO T 27 and AASHTO T 11. Furnish crushed aggregate uniformly graded from coarse to fine and free of organic matter, lumps or balls of clay, and other deleterious material.

# Sleighville SA

## Forest Service Supplemental Specifications

Delete Table 703-2 and replace with the following:

Table 703-2  
Target Value Ranges for Subbase and Base Gradation

Sieve Size	Percent by Mass Passing Designated Sieve (AASHTO T 27 and T 11)					
	Grading Designation					
	A (Subbase)	B (Subbase)	C (Base)	D (Base)	E (Base)	
2½ inch	100					
2 inch	97 – 100	100	100			
1½ inch		97 – 100				
1 inch	65 – 79 (6)		80 – 100 (6)	100		
¾ inch			64 – 94 (6)	86 – 100 (6)	100	
½ inch	45 – 59 (7)					
⅜ inch			40 – 69 (6)	51 – 82 (6)	62 – 90 (6)	
No. 4	28 – 42 (6)	40 – 60 (8)	31 – 54 (6)	36 – 64 (6)	36 – 74 (6)	
No. 40	9 – 17 (4)			12 – 26 (4)	12 – 26 (4)	
No. 200	4.0 – 8.0 (3)	4.0 – 12.0 (4)	4.0 – 7.0 (3)	4.0 – 7.0 (3)	4.0 – 7.0 (3)	

( ) The value in the parentheses is the allowable deviation (±) from the target values..

# Sleighville SA

## Forest Service Supplemental Specifications

**Delete Table 703-3 and replace with the following:**

**Table 703-3  
Target Value Ranges for Surface Gradation**

Sieve Size	Percent by Mass Passing Designated Sieve (AASHTO T 27 and T 11)								
	Grading Designation								
	F	G	H	S	T	U			
1 1/2 inch	100			100					
1 inch	97-100	100		72 - 92 (6)	100				
3/4 inch	76-89 (6)	97 - 100	97 - 100			100			
1/2 inch					71 - 91 (6)				
3/8 inch	56-68 (6)	70 - 80 (6)	80 - 92 (6)	51 - 71 (6)					71 - 90 (6)
No. 4	43-53 (7)	51 - 63 (7)	58 - 70 (7)	36 - 53 (7)	43 - 60 (7)				50 - 68 (7)
No. 8				26 - 40 (6)	30 - 46 (6)				34 - 51 (6)
No. 16	23-32 (6)	28 - 39 (6)	28 - 40 (6)						
No. 40	15-23 (5)	19 - 27 (5)	16 - 26 (5)	14 - 25 (5)	16 - 28 (5)				19 - 30 (5)
No. 200	10.0-16.0 (4)	10.0 - 16.0 (4)	9.0 - 14.0 (4)	8.0 - 15.0 (4)	8.0 - 15.0 (4)				8.0 - 15.0 (4)

( ) The value in the parentheses is the allowable deviation ( $\pm$ ) from the target values.  
If the plasticity index (PI) is greater than 0, the TV range for the No. 200 sieve size is 8-12 (4).

# Sleighville SA

Forest Service Supplemental Specifications

Add Table 703-13:

**Table 703-13**  
**Gradation Requirements for Screened Aggregate**

Sieve Size	Percent by Mass Passing Designated Sieve (AASHTO T 27 and T 11)						
	Grading Designation						
	L	M	N	O	P	Q	R
6 inch	100	100					
4 inch			100	100			
3 inch					100	100	
2 inch							100
No. 4		15-45		15-45		15-45	